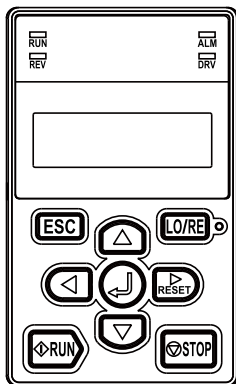


## YASKAWA AC Drive Option LED Keypad Installation Manual

Type: JVOP-KPLEA04Axx, JVOP-KPLEA04Mxx

To properly use the product, read this manual thoroughly and retain for easy reference, inspection, and maintenance. Ensure the end user receives this manual.



---

**This Page Intentionally Blank**

# Table of Contents

---

1.	Preface and Safety . . . . .	5
	Applicable Documentation . . . . .	5
	Glossary . . . . .	5
	Registered Trademarks . . . . .	6
	Supplemental Safety Information . . . . .	6
2.	Overview . . . . .	7
3.	Receiving . . . . .	7
4.	Component Names and Functions . . . . .	9
	LED Status Indicators . . . . .	12
5.	Installation Procedure . . . . .	14
	Section Safety . . . . .	14
	Remote Operation . . . . .	14
	Methods to Install a Remote Keypad . . . . .	15
	Option Dimensions . . . . .	17
	Procedure A . . . . .	18
	Procedure B . . . . .	27
6.	Basic Operation . . . . .	38
	Keypad Display Function Hierarchy . . . . .	38
	Display Screens and Functions (Default Setting) . . . . .	39
	Keypad Operation . . . . .	42

---

Set Frequency Reference to Run/Stop . . . . .	43
Monitoring Drive Status . . . . .	44
Change Parameter Setting Values. . . . .	45
Verifying and Changing Parameter Settings (Verify Menu) . . . . .	46
Switching between LOCAL Mode and REMOTE Mode . . . . .	48
Execute Auto-Tuning . . . . .	48
Read Parameter Settings from the Drive (Backup) . . . . .	52
Write Parameters Saved in the Keypad to Another Drive (Restore) . . . . .	54
Verify Parameters in Drive and Parameters Saved in Keypad (Verification). . . . .	55
7. Related Parameters. . . . .	57
8. Fault Diagnostics and Measures . . . . .	60
9. Disposal Instructions . . . . .	62
WEEE Directive. . . . .	62
10. Specification. . . . .	63
11. Warranty . . . . .	64
Warranty Period and Scope . . . . .	64
About Application of This Product . . . . .	65
Revision History . . . . .	66

# 1 Preface and Safety

## ◆ Applicable Documentation

Document	Description
YASKAWA AC Drive Option LED Keypad Manuals	<p>Read this manual first.</p> <p>The manual contains basic information required to install and wire the keypad.</p> <p>This manual is packaged with the keypad.</p>
YASKAWA AC Drive Manuals	<p>For information about drive settings, refer to the manuals for the drive on which you will use this kit.</p> <p>The manuals provide information about basic installation, wiring, operation procedures, functions, troubleshooting, and maintenance.</p> <p>The manuals also include important information about parameter settings and tuning the drive.</p> <p>You can download drive manuals from the Yaskawa product and technical information website shown on the back cover of this manual.</p>

### Note:

This manual shows typical examples. Different drive models can have different functions. Refer to the drive manuals for more information.

## ◆ Glossary

- Drive:
  - YASKAWA AC Drive GA500
  - YASKAWA AC Drive GA700
  - YASKAWA AC Drive GA800
  - YASKAWA AC Drive CR700
  - YASKAWA AC Drive CH700
- Keypad: YASKAWA AC Drive Option LED Keypad

### ◆ Registered Trademarks

Company names and product names mentioned in this manual are trademarks of those companies.

---

### ◆ Supplemental Safety Information

Read and understand this manual before you install, operate, or do maintenance on the option. Use this option as specified by this manual and local codes.

The symbol marks in this section identify safety messages in this manual. If you do not obey these safety messages, the hazards can cause serious injury, death, or damage to the products and related equipment and systems.

**⚠ DANGER** *This signal word identifies a hazard that will cause serious injury or death if you do not prevent it.*

**⚠ WARNING** *This signal word identifies a hazard that can cause death or serious injuries if you do not prevent it.*

**⚠ CAUTION** *Identifies a hazardous situation, which, if not avoided, can cause minor or moderate injury.*

**NOTICE** *This signal word identifies a property damage message that is not related to personal injury.*

### ■ General Safety

#### General Precautions

- The figures in this manual can possibly include options and drives without covers or safety shields to show detail. Install missing covers or safety shields before you operate the drive. Use the option only as specified by the instructions in this manual.
- The diagrams in this manual are only examples and are not always related to all the products included in this manual.
- Yaskawa can change the products and specifications in this manual or the content and presentation of the manual without notice to improve the product and/or the manual.
- If you damage or lose manuals, contact a Yaskawa representative or the nearest Yaskawa sales office shown on the rear cover of the manual, and tell them the document number on the front cover to order new copies.

**⚠ DANGER**

*Do not ignore the safety messages in this manual. If you ignore the safety messages in this manual, it will cause serious injury or death. The manufacturer is not responsible for injuries or damage to equipment.*

## 2 Overview

Connect the keypad option to the drive to perform the following basic operations:

- Read or modify drive parameter settings
- Back up, restore, and verify drive parameters
- Operate and stop the drive
- Monitor drive operation status

**Note:**

This product has no clock function.

### ◆ Compatible Products

Product Series	Drive Software Version *1
GA500	All
GA700	All
GA800	All
CR700	All
CH700	All


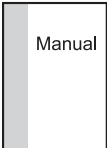
\*1 Refer to "PRG" on the drive nameplate for the software version number.

## 3 Receiving

1. Make sure that the keypad is not damaged and no parts are missing.  
Immediately contact the shipping company if the option or other parts are damaged. The Yaskawa warranty does not include damage from shipping.

2. Make sure that the model number on the option nameplate and the model shown in the purchase order are the same. Immediately contact the distributor where you purchased the option or the Yaskawa sales office about problems with the option.

### ◆ Option Package Contents

Option Contents		Quantity
LED Keypad	 <p>The image shows a rectangular LED keypad with a small display screen at the top. Below the screen are several function buttons: ESC, a triangle up button, LO/RE, a left arrow button, a center button with a square, a right arrow button, a triangle down button, a RUN button with a right arrow, and a STOP button with a square.</p>	1
Instruction Manual	 <p>The image shows a vertical rectangular manual with the word "Manual" printed in the center.</p>	1



## 4 Component Names and Functions

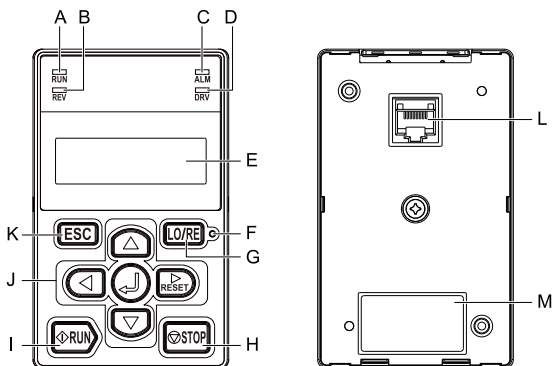




















Figure 4.1 Keypad Components




-	Key and LED	Function
A	RUN LED 	Illuminates to show that the drive is operating the motor.
B	REV LED 	Illuminates when a reverse Run command is active.
C	ALM LED 	Illuminates when the drive detects a fault.
D	DRV LED 	Illuminates when the drive is in Drive Mode.




## 4 Component Names and Functions

-	Key and LED	Function
E	LED Display Panel	<p>Displays data, parameters, and errors.</p> <p><b>Note:</b> This manual uses radiating triangles to show flashing digital characters on the keypad as in this figure:</p> 
F	LO/RE LED 	<p>Illuminates to identify when the drive is operating in LOCAL Mode.</p>
G	LO/RE Selection Key 	<p>Switches drive control for the Run command and frequency reference between the keypad (LOCAL) and an external source (REMOTE).</p> <p><b>Note:</b></p> <ul style="list-style-type: none"> <li>The drive will not switch between LOCAL Mode and REMOTE Mode when it is receiving a Run command from an external source.</li> <li>Stop operation to enable the LO/RE Selection Key when in Drive Mode. Set <math>o2-01 = 0</math> [LO/RE Key <i>Function Selection = Disabled</i>] to disable  when switching from REMOTE to LOCAL will have a negative effect on system performance.</li> </ul>
H	STOP Key 	<p>Stops drive operation.</p> <p><b>Note:</b></p> <p>Push  to stop the motor. This will also apply when a Run command (REMOTE Mode) is active at an external Run command source. Set <math>o2-02 = 0</math> [STOP Key <i>Function Selection = Disabled</i>] to disable  in REMOTE Mode.</p>
I	RUN Key 	<p>Starts the drive in LOCAL Mode.</p> <p><b>Note:</b></p> <p>Push the LO/RE Selection Key on the keypad to set the drive to LOCAL Mode before you use the keypad to operate the motor.</p>

-	Key and LED	Function
J	Left Arrow Key 	Moves the cursor to the left.
	Up Arrow Key/ Down Arrow Key  / 	<ul style="list-style-type: none"> <li>• Scrolls up or down to show the next item or the previous item.</li> <li>• Selects parameter numbers and increments/decrements setting values.</li> </ul>
	Right Arrow Key (RESET) 	<ul style="list-style-type: none"> <li>• Moves the cursor to the right.</li> <li>• Clears drive faults.</li> </ul>
	ENTER Key 	<ul style="list-style-type: none"> <li>• Enters parameter values and settings.</li> <li>• Selects a menu item to navigate between displays.</li> </ul>
K	ESC Key 	<ul style="list-style-type: none"> <li>• Goes back to the previous display.</li> <li>• Push and hold this key to go back to the Frequency Reference display.</li> </ul>
L	Cable Connector	Connects to the drive using an RJ-45 8-pin straight through UTP CAT5e extension cable or keypad connector.
M	Nameplate	Shows the model number of the keypad and other information <b>Note:</b> "REV" on the nameplate identifies the hardware and software version of the keypad.

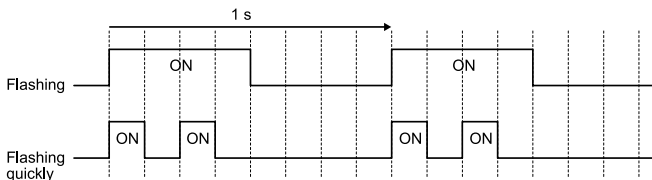
## ◆ LED Status Indicators

LED	State	Drive Status
RUN LED 	Illuminated	The drive is operating the motor.
	Flashing	<ul style="list-style-type: none"> <li>The drive is decelerating to stop.</li> <li>The drive received a Run command with a frequency reference of 0 Hz while the drive is set to a mode other than a control mode with zero speed control.</li> <li>The drive received a DC Injection Braking command.</li> </ul>
	Flashing Quickly	<ul style="list-style-type: none"> <li>The drive received a Run command from the external source and is switching to REMOTE Mode while the drive is in LOCAL Mode.</li> <li>The drive received a Run command from an external source and the drive is not in Drive Ready (READY) condition.</li> <li>The drive received a Fast Stop command.</li> <li>The safety function shut off output.</li> <li>You pushed  on the keypad while the drive is operating in REMOTE Mode.</li> <li>The drive is energized with an active Run command and <math>b1-17 = 0</math> [Run Command at Power Up = Disregard Existing RUN Command].</li> <li>The drive is set to coast-to-stop with timer (<math>b1-03 = 3</math> [Stopping Method Selection = coast to stop with timer]) with the Run command disabled, and you activated the Run command during the Run wait time.</li> <li>The drive received a DC Injection Braking command.</li> </ul>
	OFF	The drive stops.
REV LED 	Illuminated	The drive received a reverse Run command.
	OFF	The drive received a forward Run command.

LED	State	Drive Status
ALM LED 	Illuminated	The drive detected a fault.
	Flashing	The drive detected one of the following: <ul style="list-style-type: none"> <li>• A Minor fault, an alarm</li> <li>• An oPE parameter setting error</li> <li>• A fault or error during Auto-Tuning</li> </ul> <b>Note:</b> The digital characters displayed on the keypad will also flash.
	OFF	The drive is in regular operation without alarms or faults.
DRV LED 	Illuminated	The drive is in Drive Mode.
	Flashing	You are using DriveWorksEZ. <b>Note:</b> Refer to the DriveWorksEZ instruction manual for details regarding DriveWorksEZ.
	OFF	The drive is in Programming Mode.
LO/RE LED 	Illuminated	The keypad is selected for Run command control (LOCAL).
	OFF	A device other than the keypad is selected for Run command control (REMOTE).

### ■ LED Flashing Statuses

Refer to [Figure 4.2](#) and [Figure 4.3](#) for information about the differences between flashing and flashing quickly.



**Figure 4.2 LED Flashing Statuses**

## 5 Installation Procedure

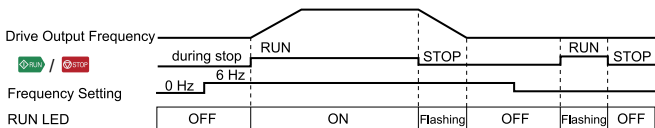


Figure 4.3 Relation between RUN LED and Drive Operation

## 5 Installation Procedure

### ◆ Section Safety

**NOTICE** *Damage to Equipment. Correctly connect all pins and connectors. If the pins and connectors are incorrect, it can cause damage to equipment and incorrect operation.*

**NOTICE** *Damage to Equipment. Do not bend the communication cables more than the bend radius specifications. If you bend the cables too much, it can break the wires and loosen connections.*

#### Note:

Use Yaskawa connection cables or recommended cables only. Incorrect cables can cause the drive or option to function incorrectly.

### ◆ Remote Operation

You can remove the digital operator and use a 3 m (9.8 ft.) length maximum extension cable to connect it to the drive. The option makes it easier to operate the drive when you install the drive in a location where you cannot easily access it. Contact Yaskawa or your nearest sales representative to order optional accessories.

## ◆ Methods to Install a Remote Keypad

Installation Method	Description	Required Tools
External/Face-Mount	Installs the option on the outside of the panel. An optional installation bracket is not necessary for this installation.	Phillips screwdriver #2 (M3)
Internal/Flush-Mount	Encloses the keypad in the panel. The front of the keypad is flush with the outside of the panel.	<ul style="list-style-type: none"> <li>Phillips screwdriver #2 (M3, M4)</li> <li>Installation support set A (for mounting with screws, model: 900-192-933-001)</li> </ul>
		<ul style="list-style-type: none"> <li>Phillips screwdriver #2 (M3)</li> <li>Wrench (M4)</li> <li>Installation support set B (for mounting with nut clamp, model: 900-192-933-002)</li> </ul>

### Note:

Installation support sets are sold separately. When there are weld studs on the interior of the control panel, use installation support set B.

## ■ Installation Procedure


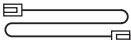


The installation procedure is different for different drives.

Drive	Procedure	Page
GA700, GA800, CR700, CH700	A	18
GA500	B	27

## ■ Optional Items

The optional extension cable and installation support set are necessary for Internal/Flush-Mount installation.

Contact Yaskawa or your nearest sales representative to order optional items.

Item	Part Number	Notes
Extension cable (1 m (3.3 ft.)) 	WV001 *1	Connects the keypad for remote operation. <ul style="list-style-type: none"> <li>RJ-45 8-pin straight through</li> <li>UTP CAT5e cable (1 m (3.3 ft.)/3 m (9.8 ft.))</li> </ul>
Extension cable (3 m (9.8 ft.)) 	WV003 *1	<div style="background-color: #0070C0; color: white; padding: 2px;"><b>NOTICE</b></div> <i>Damage to Equipment. Do not use this cable to connect the drive to a PC. Failure to obey will cause damage to the PC.</i>
Installation support set A (screw clamp) 	900-192-933-001	Encloses the keypad in the panel. <ul style="list-style-type: none"> <li>M3 screws: 6 mm (0.24 in.) depth Phillips recessed pan head machine screws (2)</li> <li>M4 screws: 10 mm (0.39 in.) depth Phillips truss head screws (4) (for panel thickness of 1 to 1.6 mm (0.04 to 0.06 in.))</li> </ul>
Installation support set B (nut clamp) 	900-192-933-002	Encloses the keypad in the panel. When there are weld studs on the interior of the control panel, use the installation support set B (nut clamp). <ul style="list-style-type: none"> <li>M3 screws: 6 mm (0.24 in.) depth Phillips recessed pan head machine screws (2)</li> </ul>

\*1 Part numbers for the U.S.A. are UWR0051 and UWR0052. Contact Yaskawa or your nearest sales representative for more information.



## ■ Option Dimensions

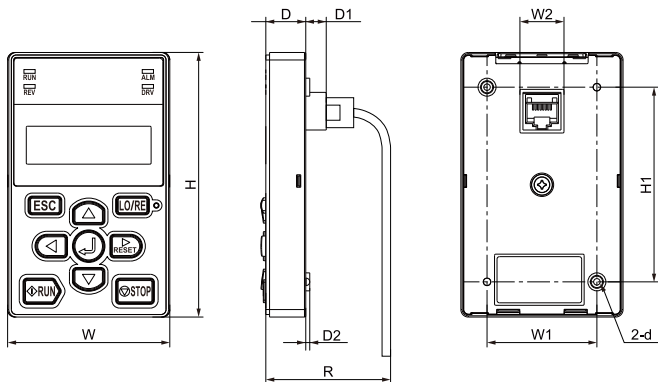


Figure 5.1 Dimensions

Table 5.1 Dimensions mm (in.)

W	H	D	D1	D2	R *1	W1	W2	H1	d
65 (2.56)	106 (4.17)	16 (0.63)	8.2 (0.32)	1.6 (0.06)	$\geq 53.8$ (2.12)	44 (1.73)	15 (0.59)	78 (3.07)	M3

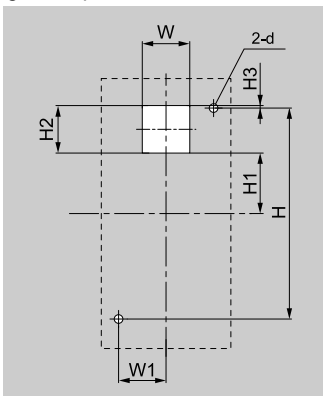
\*1 Minimum bending radius

**NOTICE** *Damage to Equipment. Do not bend the communication cables more than the bend radius specifications. If you bend the cables too much, it can break the wires and loosen connections.*

## ■ Procedure A

### External/Face-Mount Installation

1. Use the dimensions in [Table 5.2](#) and [Figure 5.2](#) to cut an opening and tap two holes in the enclosure panel.

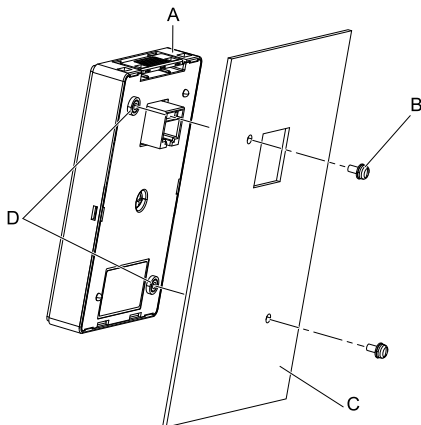


**Figure 5.2 External/Face Mount Enclosure Panel Cut-Out Dimensions**

**Table 5.2 Enclosure Panel Cut-Out Dimensions mm (in.)**

W	H	W1	H1	H2	H3	d
22 (0.87)	78 (3.07)	22 (0.87)	29 (1.14)	22 (0.87)	1 (0.04)	3.6 (0.14)

- Use M3 screws (6 mm (2.4 in) depth cross-recessed pan head screws) to attach the keypad from the inside as shown in [Figure 5.3](#).



A - Keypad

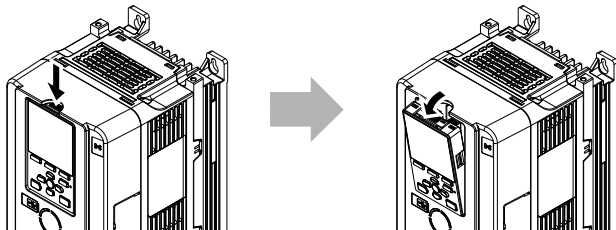
B - M3 screws

C - Enclosure panel

D - Screw mounting holes

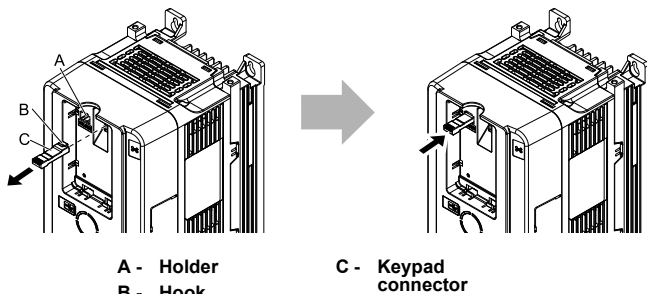
**Figure 5.3 External/Face-Mount Installation**

- Push the tab on the top of the drive keypad and carefully pull forward to remove the keypad from the drive.



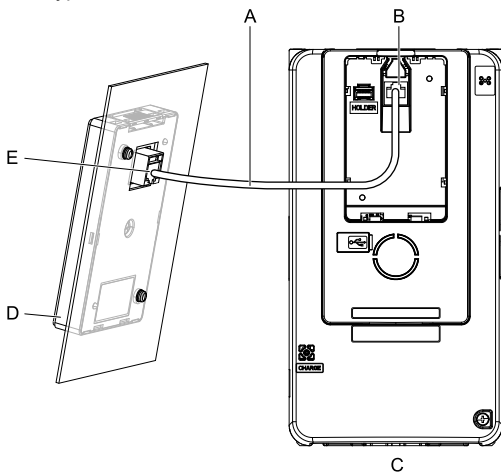
**Figure 5.4 Removing the Included Drive Keypad**

4. Remove the keypad connector and put the keypad connector in the holder on the front cover.



**Figure 5.5 Moving the Keypad Connector to the Holder**

5. Use the extension cable to connect the drive to the keypad.



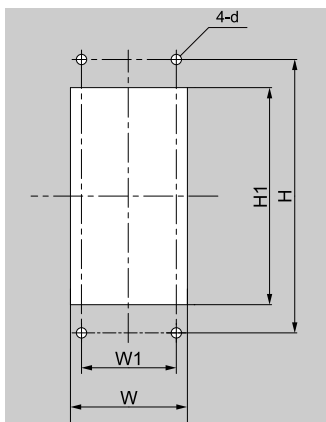
- |                              |                     |
|------------------------------|---------------------|
| A - Extension cable          | D - Keypad          |
| B - Communications connector | E - Cable connector |
| C - Drive                    |                     |

**Figure 5.6 Connecting the Drive and Keypad with the Extension Cable**

#### Internal/Flush-Mount Installation

Installation support sets A or B (sold separately) are necessary for Internal/Flush-Mount installation. The installation procedure is the same for installation support sets A and B. Contact Yaskawa or your nearest sales representative to order optional items.

1. Use the dimensions in [Table 5.3](#) and [Figure 5.7](#) to cut an opening and tap two holes in the enclosure panel.  
The panel cut-out dimensions are the same for installation support sets A and B.

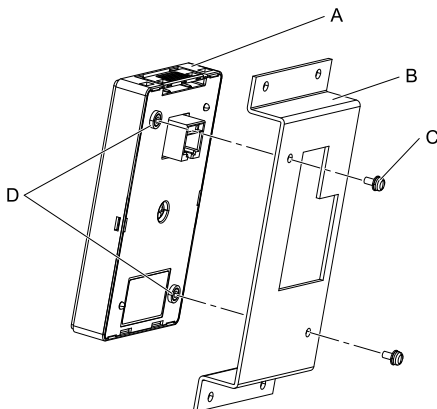


**Figure 5.7 Internal/Flush-Mount Enclosure Panel Cut-Out Dimensions**

**Table 5.3 Enclosure Panel Cut-Out Dimensions mm (in.)**

W	H	W1	H1	d
64 + 0.5 (2.52 + 0.02)	130 (5.12)	45 (1.77)	105 + 0.5 (4.13 + 0.02)	4.8 (0.19)

2. Use the screws included in the support set as shown in [Figure 5.8](#) to attach the keypad to the installation support.



A - Keypad  
B - Installation  
support set A

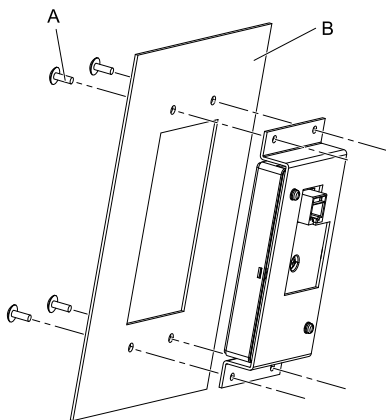
C - M3 screws  
D - Screw mounting  
holes

**Figure 5.8 Mounting the Keypad to Installation Support Set A**

3. Use the M4 screws included in the support set as shown in [Figure 5.9](#) to attach the installation support and keypad to the enclosure panel.

**Note:**

Use a gasket between the control panel and the keypad in areas where dust or other airborne unwanted materials could cause damage to the drive.



A - M4 screws

B - Enclosure panel

### Figure 5.9 Internal/Flush-Mount Installation

4. Push the tab on the top of the drive keypad and carefully pull forward to remove the keypad from the drive.

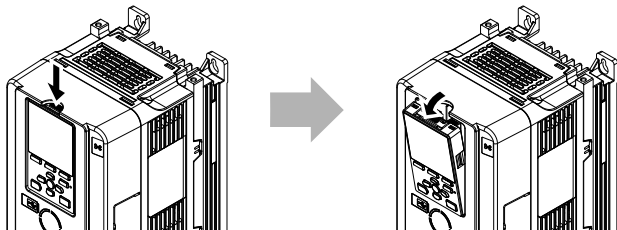
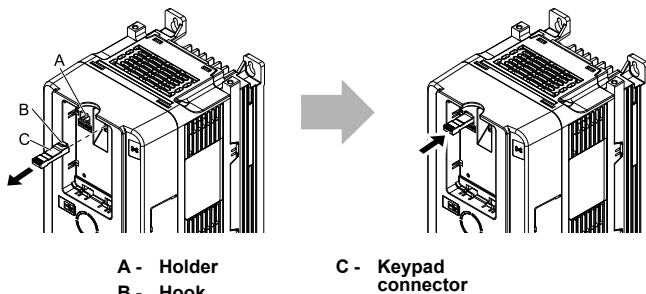


Figure 5.10 Removing the Included Drive Keypad

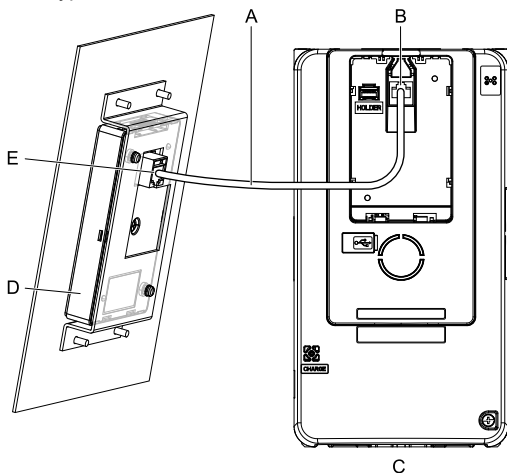


5. Remove the keypad connector and put the keypad connector in the holder on the front cover.



**Figure 5.11 Moving the Keypad Connector to the Holder**

6. Use the extension cable to connect the drive to the keypad.



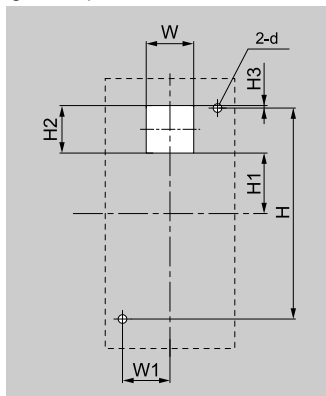
- A - Extension cable      D - Keypad  
B - Communications connector      E - Cable connector  
C - Drive

**Figure 5.12 Connecting the Drive and Keypad with the Extension Cable**

## ■ Procedure B

### External/Face-Mount Installation

1. Use the dimensions in [Table 5.4](#) and [Figure 5.13](#) to cut an opening and tap two holes in the enclosure panel.

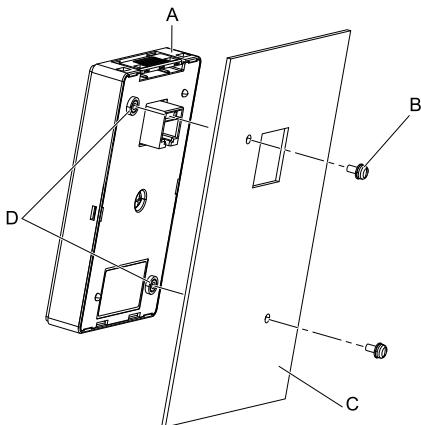


**Figure 5.13 External/Face Mount Enclosure Panel Cut-Out Dimensions**

**Table 5.4 Enclosure Panel Cut-Out Dimensions mm (in.)**

W	H	W1	H1	H2	H3	d
22 (0.87)	78 (3.07)	22 (0.87)	29 (1.14)	22 (0.87)	1 (0.04)	3.6 (0.14)

2. Use M3 screws (6 mm (0.24 in) depth cross-recessed pan head screws) to attach the keypad from the inside as shown in [Figure 5.14](#).



**A - Keypad**

**B - M3 screws**

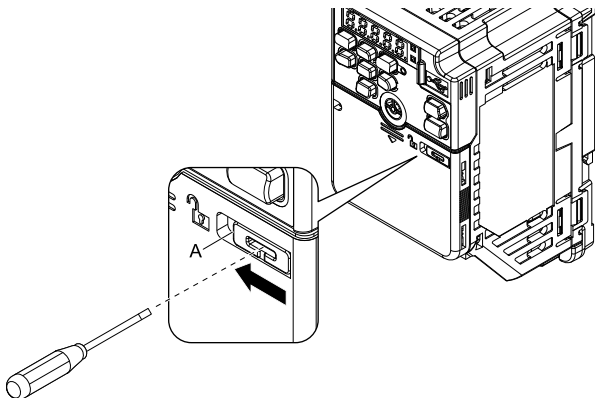
**C - Enclosure panel**

**D - Screw mounting holes**

**Figure 5.14 External/Face-Mount Installation**

3. Use a slotted screwdriver to unlock the front cover of the drive.

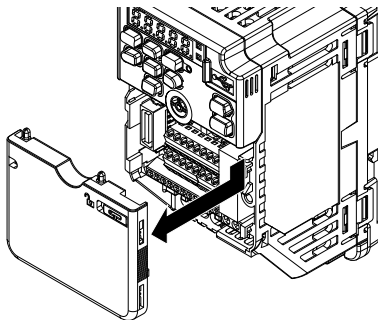
Use a slotted screwdriver with a tip width of 2.5 mm (0.1 in) or less and a thickness of 0.4 mm (0.02 in) or less.



**A - Front cover lock**

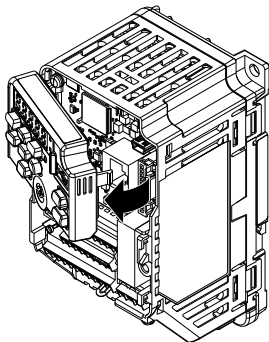
**Figure 5.15 Unlocking**

4. Slide the front cover down and remove it from the drive.



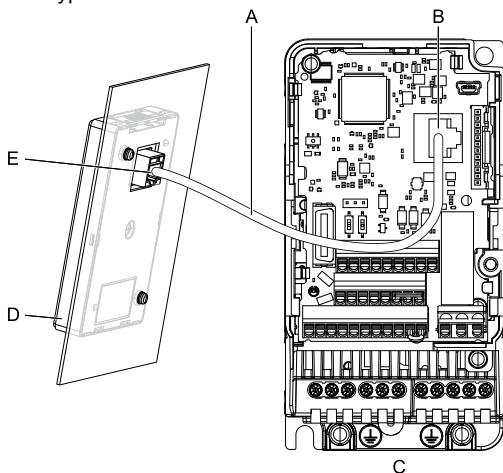
**Figure 5.16 Remove the Front Cover**

5. Push on the tab on the right side of the keypad, then pull the keypad forward to remove it from the drive.



**Figure 5.17 Removing the Included Drive Keypad**

- Use the extension cable to connect the drive to the keypad.



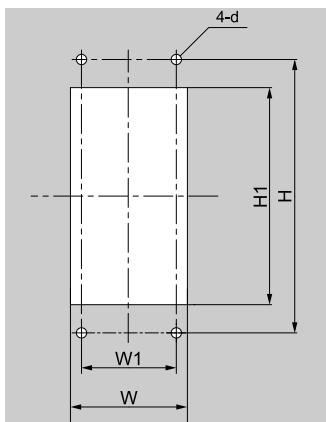
- |                              |                     |
|------------------------------|---------------------|
| A - Extension cable          | D - Keypad          |
| B - Communications connector | E - Cable connector |
| C - Drive                    |                     |

**Figure 5.18 Connecting the Drive and Keypad with the Extension Cable**

#### Internal/Flush-Mount Installation

Installation support sets A or B (sold separately) are necessary for Internal/Flush-Mount installation. The installation procedure is the same for installation support sets A and B. Contact Yaskawa or your nearest sales representative to order optional items.

- Use the dimensions in [Table 5.5](#) and [Figure 5.19](#) to cut an opening and tap two holes in the enclosure panel. The panel cut-out dimensions are the same for installation support sets A and B.



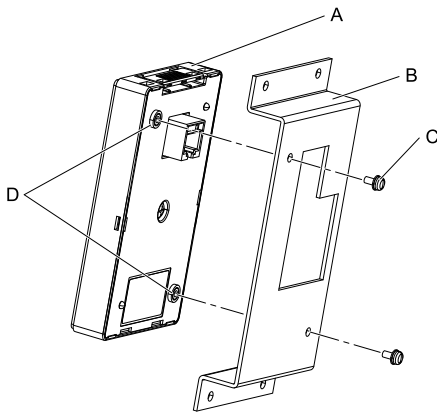
**Figure 5.19 Internal/Flush-Mount Enclosure Panel Cut-Out Dimensions**

**Table 5.5 Enclosure Panel Cut-Out Dimensions mm (in.)**

W	H	W1	H1	d
64 + 0.5 (2.52 + 0.02)	130 (5.12)	45 (1.77)	105 + 0.5 (4.13 + 0.02)	4.8 (0.19)



2. Use the screws included in the support set as shown in [Figure 5.20](#) to attach the keypad to the installation support.



A - Keypad  
B - Installation  
support set A

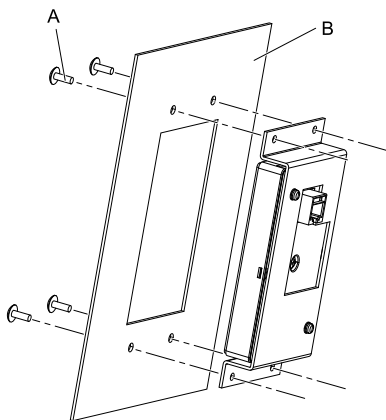
C - M3 screws  
D - Screw mounting  
holes

**Figure 5.20 Mounting the Keypad to Installation Support Set A**

3. Use the M4 screws included in the support set as shown in [Figure 5.21](#) to attach the installation support and keypad to the enclosure panel.

**Note:**

Use a gasket between the control panel and the keypad in areas where dust or other airborne unwanted materials could cause damage to the drive.



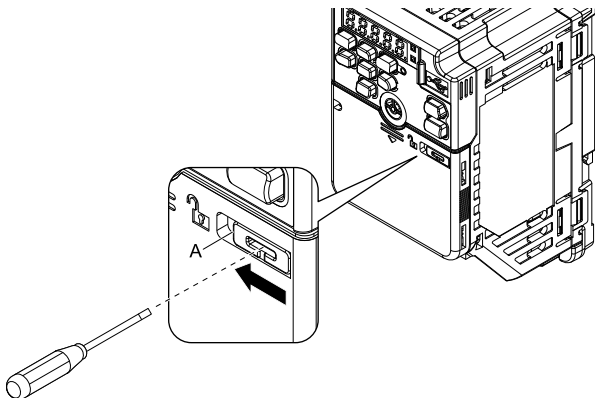
**A - M4 Screws**

**B - Enclosure panel**

### Figure 5.21 Internal/Flush-Mount Installation

4. Use a slotted screwdriver to unlock the front cover of the drive.

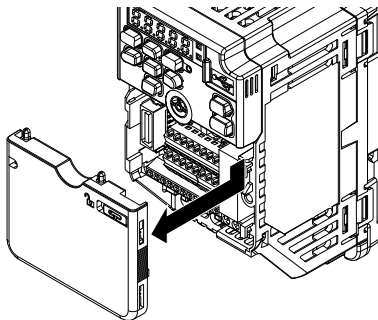
Use a slotted screwdriver with a tip width of 2.5 mm (0.1 in) or less and a thickness of 0.4 mm (0.02 in) or less.



**A - Front cover lock**

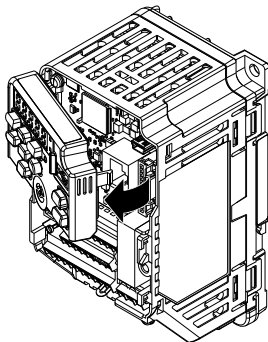
**Figure 5.22 Unlocking**

5. Slide the front cover down and remove it from the drive.



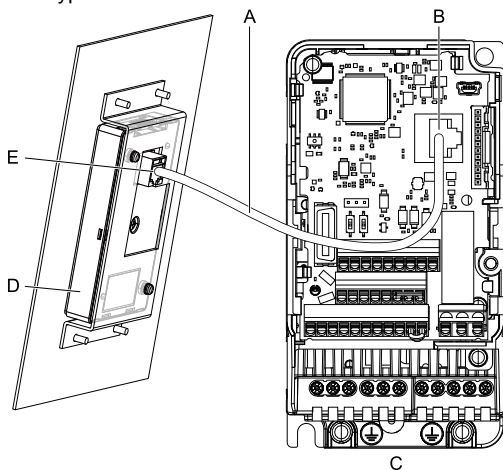
**Figure 5.23 Remove the Front Cover**

6. Push on the tab on the right side of the keypad, then pull the keypad forward to remove it from the drive.



**Figure 5.24 Removing the Included Drive Keypad**

7. Use the extension cable to connect the drive to the keypad.



- A - Extension cable    D - Keypad  
B - Communications connector    E - Cable connector  
C - Drive

**Figure 5.25 Connecting the Drive and Keypad with the Extension Cable**

## 6 Basic Operation

## ◆ Keypad Display Function Hierarchy

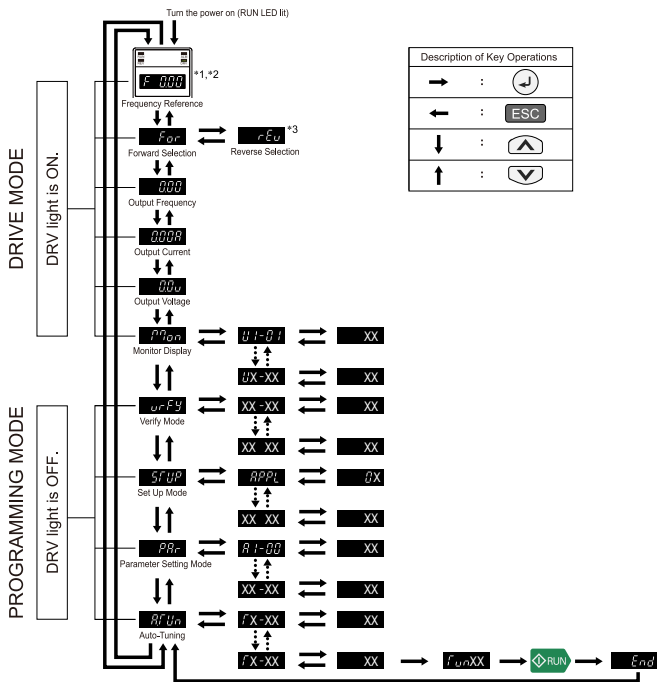






Figure 6.1 Keypad Display Function Hierarchy

- \*1 The code shown in the leftmost position is different for different *o1-03* [*Frequency Display Unit Selection*] settings. The letters in the code identify different units:
- F: 0.01 Hz units
  - P: 0.01% units
  - N: min<sup>-1</sup> units
  - u: arbitrary units
- \*2 When *o2-05 = 1* [*Home Mode Freq Ref Entry Mode = Immediate / MOP-style*], the code flashes.
- \*3 You can only select  (Reverse) in LOCAL Mode.

**Note:**

- The DRV LED will illuminate in Drive Mode.
- Push  to rotate the motor in LOCAL Mode.
-  will illuminate in LOCAL Mode.
- If you push  in Programming Mode, it will not rotate the motor.
- The actual setting value will replace “XX” in the diagram.
- Set *b1-08* [*Run Command Select in PRG Mode*] to accept or reject the Run command from an external source when in Programming Mode.
  - Set *b1-08 = 0* [*Disregard RUN while Programming*] to reject the Run command.
  - Set *b1-08 = 1* [*Accept RUN while Programming*] to accept the Run command.
  - Set *b1-08 = 2* [*Allow Programming Only at Stop*] to block changes from Drive Mode to Programming Mode while the drive is in operation.

## ◆ Display Screens and Functions (Default Setting)



When you first energize the drive, the factory default is to operate in Drive Mode.  Use and  to switch between display screens.

Table 6.1 Display Screens and Functions at Power-On


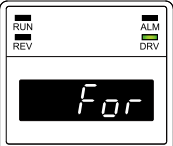
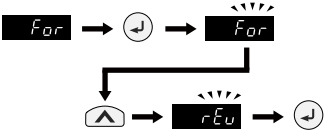

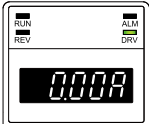


Display Screen	Function
 <p>Frequency Reference Display (default setting)</p>	<p>You can monitor and change the frequency reference while the drive is running.</p> <p><b>Note:</b> Set <i>o1-02 [Monitor Selection at Power-up]</i> to select the data displayed when you first energize the drive.</p>



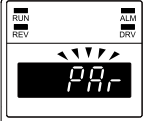


Table 6.2 Drive Mode Display Screens and Functions

Display Screen	Function
 <p>Forward/Reverse Run Selection</p>	<p><b>For</b> : The motor runs forward.</p> <p><b>rEv</b> : The motor runs reverse.</p> <p><b>Note:</b> Set <i>b1-04 [Reverse Operation Selection]</i> to prevent the reverse Run command in applications, for example fans or pumps, where reverse motor rotation can be dangerous.</p>  <p><b>Figure 6.2 Setting Reverse Run</b></p>
 <p>Output Frequency Display</p>	<p>You can monitor the frequency output from the drive.</p>



Display Screen	Function
 <p>Output current display</p>	<p>Monitors drive output current.</p>
 <p>Output Voltage Display (default setting)</p>	<p>Monitors the output voltage reference. Set <i>o1-01 [User Monitor Selection]</i> to change the item shown on this screen.</p>
 <p>Monitor Display</p>	<p>Shows the <i>U monitor</i>. Monitors drive status, information when a fault occurs, and other information related to drive operation.</p>

**Table 6.3 Programming Mode Display Screens and Functions**

Display Screen	Function
 <p data-bbox="129 390 253 419">Verify Menu</p>	<p data-bbox="332 208 875 234">Lists all parameters that are not at their default settings.</p>
 <p data-bbox="129 623 253 652">Setup Mode</p>	<p data-bbox="332 441 844 492">Shows and sets basic parameters necessary for drive operation.</p> <p data-bbox="370 502 429 528"><b>Note:</b></p> <p data-bbox="370 535 854 608">The parameters shown in the Setup Mode are different for different <i>A1-06 [Application Preset]</i> settings.</p>
 <p data-bbox="73 848 311 877">Parameter Setting Mode</p>	<p data-bbox="332 674 632 700">Shows and sets all parameters.</p>
 <p data-bbox="98 1081 289 1108">Auto-Tuning Mode</p>	<p data-bbox="332 902 854 953">The drive automatically calculates and sets the motor parameters.</p> <p data-bbox="332 965 819 1030">  Push to return the display to the frequency reference display screen.         </p>

## ◆ Keypad Operation

This section shows an example of how to use the keypad to operate the drive.

### Note:


The LED display panel in the operating example is an example. The display is different for different parameter settings.

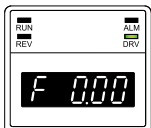
## ■ Set Frequency Reference to Run/Stop



Push **LO/RE** to set the mode to LOCAL when  $b1-01 \neq 0$  [Frequency Reference Selection 1  $\neq$  Keypad].

Push **RUN** and **STOP** on the keypad to operate the drive.


Example drive operation: Change the frequency reference from F0.00 (0 Hz) to F6.00 (6 Hz).

1. Push and hold **ESC** to show the frequency reference display screen.
2. Push .



3. Push  or  to select the digit to change. The digit will flash.



4. Push  six times to change the value to 06.00.



5. Push [ENTER Key] to set the new value.



- Push **ESC** to go back to the frequency reference display screen.



- Push **RUN** to rotate the motor at 6 Hz and illuminate



- Push **STOP**.



- RUN** flashes while the motor decelerates.



- RUN** turns OFF when the motor comes to a complete stop.



### ■ Monitoring Drive Status

- Push and hold **ESC** to show the frequency reference display screen.
- Push **▲** or **▼** to show **mon** (Monitor Display).



- Push **↶**.



4. Push  to show the monitor number that you will monitor, and push .





The keypad shows the monitor details.



### ■ Change Parameter Setting Values




The following example drive operation shows how to change *C1-01* [Acceleration Time 1] from 10.0 s (default setting) to 20.0 s.

1. Push and hold **ESC** to show the frequency reference display screen.
2. Push  or  to show **SRUP** (Setup Menu).




3. Push  to show the Parameter Settings screen.

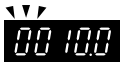



4. Push  or  to select **C1-01**, then push   
**C1-01** [ENTER Key].



The LED display shows the current setting value (10.0 s), and the leftmost digit flashes.

5. Push  two times to select the digit to change. The 1 will flash.




6. Push  to change the value to 0020.0.



7. Push [ENTER Key] to set the new value and complete the parameter change.





The LED display shows  and the display automatically goes back to the Parameter Settings screen.





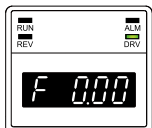
## ■ Verifying and Changing Parameter Settings (Verify Menu)




The Verify Menu shows parameters that are not at their default values. You can also use this menu to quickly access and edit changed parameters and is very useful when you replace a drive.

The LED display panel will show  when all parameters are at their default values.




1. Push and hold  to show the frequency reference display screen.

2. Push  or  to show **urF4** (Verify Menu).





3. Push  to show parameters that are not at their default settings. Push  or  to scroll through the changed parameters.




4. To change a parameter again in the Verify Menu, push  or  to select the parameter to change, then push .



5. Push  to select the digit to change. The digit will flash. Push  to change the value.




6. Push  to set the new value and complete the parameter change.



The LED display shows **End** and the display automatically goes back to the Parameter Settings screen.



### ■ Switching between LOCAL Mode and REMOTE Mode


**▲ WARNING** *Sudden Movement Hazard. If you change the control source when b1-07 = 1 [LOCAL/REMOTE Run Selection = Accept Existing RUN Command], the drive can start suddenly. Before you change the control source, remove all personnel from the area around the drive, motor, and load. Sudden starts can cause serious injury or death.*

1. Make sure that  is OFF and the drive is stopped.

**Note:**

Switching between LOCAL Mode and REMOTE Mode is not possible when the drive receives a Run command.

2. Push and hold  to show the frequency reference display screen.
3. Push  to switch between LOCAL Mode and REMOTE Mode.

The mode switches each time  is pushed.

- Local Mode: The LO/RE LED illuminates.
- Remote Mode: The LO/RE LED is OFF.

### ■ Execute Auto-Tuning

Auto-Tuning automatically adjusts parameters based on motor characteristics.

Refer to the motor nameplate or the motor test report regarding the information required for Auto-Tuning.



VARTISPEED										
3-PHASE PERMANENT MAGNET MOTOR										
TYPE SST4-					POLES E5-04					
PROTECTION					COOLING					
kW	V	Hz	RATING		A	r/min	r <sub>i</sub>	E5-05		
E5-02	E1-05				E5-03	E1-04, 06	Ld	E5-06		
							Lq	E5-07		
							Ke	E5-09		
INS. COOLANT TEMP.					°C	ALTITUDE		m	Δθ	E5-11
STD					MASS		kg			Δθ'
BRG NO	DRIVE END				OPP END		K <sub>i</sub>			
SER NO	YEAR				K <sub>t</sub>					
YASKAWA ELECTRIC CORPORATION							JAPAN			S <sub>i</sub>

**Figure 6.3 Motor Nameplate (Example)**

**⚠ WARNING** *Sudden Movement Hazard. Before you do Auto-Tuning, remove all personnel and objects from the area around the drive, motor, and load. The drive and motor can start suddenly during Auto-Tuning and cause serious injury or death.*

**⚠ WARNING** *Electrical Shock Hazard. During Auto-Tuning, the motor will receive high voltage when the motor is stopped. Do not touch the motor until Auto-Tuning is complete. If you touch a motor that is energized, it can cause serious injury or death.*

**⚠ WARNING** *Sudden Movement Hazard.. Before you do Rotational Auto-Tuning, disconnect the load from the motor. The load can move suddenly and cause serious injury or death.*

## Note:







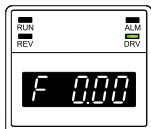
- Pushing  or experiencing an error before completing Auto-Tuning will interrupt Auto-Tuning and trigger a fault.
  - Endx* identifies that Auto-Tuning has successfully completed with discrepancies in the calculations. Fix the cause of the detected error and perform Auto-Tuning again, or manually set the motor parameters. It is acceptable to use the drive in the application if the cause cannot be identified despite the existence of an *Endx* error.
  - Er-xx* indicates that Auto-Tuning has not completed successfully. Fix the cause of the detected error and perform Auto-Tuning again.
- Release the holding brake before you do Rotational Auto-Tuning. A closed holding brake during Rotational Auto-Tuning can cause incorrect operation.




Figure 6.4 Error Code Example

This procedure shows how to do Rotational Auto-Tuning on an induction motor.

- Make sure that  is OFF and the drive is stopped.
- Push and hold  to show the frequency reference display screen.
- Push  or  to show  (Auto-Tuning).



- Push  to show the Parameter Settings screen (*T0-00 [Tuning Mode Selection]*).



5. Push  to select **F1-01**, and push .





6. Push  or , select **00** (Rotational Auto-Tuning), and push .



The display automatically goes back to the Parameter Settings screen.

7. Push  to select **F1-02** (Motor Rated Power), and push .



8. Push  to select the digit to change. The digit will flash. Push  to change the value. Input information based on the motor nameplate.  
Example: 0.75 kW to 0.4 kW




9. Push .




The LED display shows **End** and the display automatically goes back to the Parameter Settings screen.


A black rectangular LED display with three small upward-pointing triangles above it. The display shows the text "T1-02" in a white, digital font.

10. Repeat steps 6 through 9 to input these parameter setting values.
- T1-02 [Motor Rated Power]
  - T1-03 [Motor Rated Voltage]
  - T1-04 [Motor Rated Current]
  - T1-05 [Motor Base Frequency]
  - T1-06 [Number of Motor Poles]
  - T1-07 [Motor Base Speed]
  - T1-08 [Encoder Pulse Count (PPR)]: Input when setting A1-02 = 3 [Control Method Selection = Closed Loop Vector].
11. Push .

A black rectangular LED display with three small upward-pointing triangles above it. The display shows the text "T1-07" in a white, digital font.

12. Push .

A black rectangular LED display with three small upward-pointing triangles above it. The display shows the text "Tun 10" in a white, digital font.

-  illuminates and Auto-Tuning starts.
- For Rotational Auto-Tuning, the drive injects current into the motor for about 1 minute before rotating the motor. For Inertia Tuning, the drive immediately begins rotating the motor.
- Auto-Tuning will complete in 1 to 2 minutes.






## ■ Read Parameter Settings from the Drive (Backup)

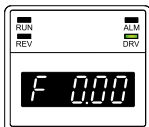
Set o3-02 = 1 [Backup Allowed = Enabled].

This operation example reads parameter settings from the drive and saves them in the keypad. The keypad will save parameters from one drive.

**Note:**




You can do keypad backup approximately 100,000 times.

1. Make sure that  is OFF and the drive is stopped.
2. Push and hold  to show the frequency reference display screen.
3. Push  or  to show  (Parameter Settings Mode).







4. Push .





5. Push  to show , and push  to move the flashing digit.



6. Push  to show , push  to move the flashing digit, and push .



7. Push  and [Up arrow key], select **01** (Backup), and push .



The keypad starts to read the parameter settings from the drive.

- The LED display shows **rEAd** while the drive is reading the settings.
- The keypad shows **End** when the drive is finished reading. The display automatically goes back to the Parameter Settings screen.







## ■ Write Parameters Saved in the Keypad to Another Drive (Restore)

This operation example writes all parameter settings saved in the keypad to another drive.

### Note:




This process will only restore parameters when the model, capacity, and control mode are the same between drives.

1. Make sure that  is OFF and the drive is stopped.
2. Push and hold  to show the frequency reference display screen.
3. Push  or  to show **PAR** (Parameter Settings Mode).







4. Push .







5. Push  to show , and push  to move the flashing digit.





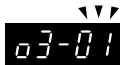
6. Push  to show , push  to move the flashing digit, and push .



7. Push  and , select  (Restore), and push .








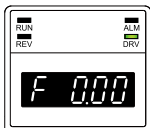
- The LED display shows  while writing.
- The keypad shows  when writing ends. The display automatically goes back to the Parameter Settings screen.



### ■ Verify Parameters in Drive and Parameters Saved in Keypad (Verification)




This operation example compares the parameters in the drive with the parameter settings saved on the keypad.

1. Make sure that  is OFF and the drive is stopped.
2. Push and hold  to show the frequency reference display screen.
3. Push  or  to show  (Parameter Settings Mode).






4. Push .






5. Push  to show , and push  to move the flashing digit.



6. Push [Up arrow key] to show , push  to move the flashing digit, and push .

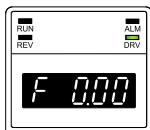


7. Push  and [Up arrow key], select  (Verify), and push .





- The LED display shows **urFy** while the drive is verifying the parameters.
  - The keypad shows **End**, and the display automatically goes back to the Parameter Settings screen when the parameter settings match.
  - The keypad shows **ndRr** or other errors if the parameter settings did not match.
8. After you verify the parameter settings, push and hold **ESC** to go back to the frequency reference display screen.






## 7 Related Parameters

These parameters set the drive to operate with the option. Set the necessary parameters. Refer to the manual packaged with the drive for more information about how to set parameters.

## 7 Related Parameters

No. (Hex.)	Name	Description	Default (Setting Range)
b1-01 (0180)	Frequency Reference Selection 1	Sets the input method for the frequency reference. 0 : Keypad 1 : Analog Input 2 : Memobus/Modbus Communications 3 : Option PCB 4 : Pulse Train Input	1 (0 - 4)
b1-02 (0181)	Run Command Selection 1	Sets the input method for the Run command. 0 : Keypad 1 : Analog Input 2 : Memobus/Modbus Communications 3 : Option PCB	1 (0 - 3)
b1-15 (01C4)	Frequency Reference Selection 2	Sets the input method for frequency reference 2. 0 : Keypad 1 : Analog Input 2 : Memobus/Modbus Communications 3 : Option PCB 4 : Pulse Train Input	0 (0 - 4)
b1-16 (01C5)	Run Command Selection 2	Sets the input method for Run Command 2 when the user switches the control circuit terminals ON/OFF to change the Run command source. 0 : Keypad 1 : Digital Input 2 : Memobus/Modbus Communications 3 : Option PCB	0 (0 - 3)
o1-03 (0502)	Frequency Display Unit Selection	Sets the display units for the frequency reference and output frequency. 0 : 0.01Hz units 1 : 0.01% units 2 : min <sup>-1</sup> (r/min) unit 3 : User Units	Determined by A1-02 (0 - 3)

No. (Hex.)	Name	Description	Default (Setting Range)
o2-01 (0505)	LO/RE Key Function Selection	Sets the function that lets you use  to switch between LOCAL and REMOTE Modes. 0 : Disabled 1 : Enabled	1 (0, 1)
o2-02 (0506)	STOP Key Function Selection	Sets the function to use  on the keypad to stop the drive when the Run command source for the drive is REMOTE (external) and not assigned to the keypad. 0 : Disabled 1 : Enabled	1 (0, 1)
o2-05 (0509)	Home Mode Freq Ref Entry Mode	Sets the function that makes it necessary to push  to use the keypad to change the frequency reference value while in Drive Mode. 0 : ENTER Key Required 1 : Immediate / MOP-style	0 (0, 1)
o2-06 (050A)	Keypad Disconnect Detection	Sets the function that stops the drive if you disconnect the keypad connection cable from the drive or if you damage the cable while the keypad is the Run command source. 0 : Disabled 1 : Enabled	1 0 (0, 1)

## 8 Fault Diagnostics and Measures

No. (Hex.)	Name	Description	Default (Setting Range)
03-01 (0515)	Copy Keypad Function Selection	Sets the function to use the keypad to save and copy drive parameters to a different drive. 0 : Copy Select 1 : Backup (drive → keypad) 2 : Restore (keypad → drive) 3 : Verify (check for mismatch) 4 : Erase (backup data of keypad)	0 (0 - 4)
03-02 (0516)	Copy Allowed Selection	Sets the copy function when 03-01 = 1 [Copy Keypad Function Selection = Backup (drive → keypad)]. 0 : Disabled 1 : Enabled	0 (0, 1)

## 8 Fault Diagnostics and Measures

### ◆ Fault Displays

The drive keypad shows Fault/Error codes to indicate specific faults or errors.

This section shows fault codes related to the keypad. Refer to the drive manual for information fault codes not shown below.

Code	Name	Causes	Possible Solutions
CPF00	Control Circuit Error	Communication with the keypad is not possible seven seconds after power is turned on.	Refer to the following causes and solutions.
		Keypad cable connector is not connected properly	<ul style="list-style-type: none"><li>Remove the keypad and connect it again.</li><li>Replace the cable if damaged.</li></ul>

Code	Name	Causes	Possible Solutions
		Faulty keypad	Replace the keypad.
		Drive control circuit error	<ul style="list-style-type: none"> <li>• Re-energize the drive.</li> <li>• Replace the drive.</li> </ul>
CPF01	Control Circuit Error	After start of communication with the keypad, a communication error occurred for approximately five seconds.	Refer to the following causes and solutions.
		Keypad cable connector is not connected properly	Remove the keypad and connect it again.
		Faulty keypad	Replace the keypad.
		Drive control circuit error	<ul style="list-style-type: none"> <li>• Re-energize the drive.</li> <li>• Replace the drive.</li> </ul>
oPr	Keypad Connection Fault	The keypad is not securely connected to the connector on the drive.	Examine the connection between the keypad and the drive.
		The connection cable between the drive and the keypad is disconnected.	<ul style="list-style-type: none"> <li>• Remove the keypad and then reconnect it.</li> <li>• Replace the cable if damaged.</li> </ul>
-	- (No Error Message)	The cable is not securely connected.	Make sure that the cable is securely connected.
		The connection cable between the drive and the keypad is disconnected.	Replace the cable if damaged.
		Faulty keypad	Replace the keypad.

### 9 Disposal Instructions

Correctly discard these parts and materials as specified by regional, local, and municipal laws and regulations for this product:

- Battery
- microSD card

**⚠ CAUTION** *Fire Hazard. Put electrical tape fully around the battery before you discard it. If you do not correctly discard the battery, it can cause a fire.*

**Note:**

- Remove the battery and microSD card from the keypad.
- You cannot recycle the battery. Discard used batteries as specified by the battery manufacturer.
- Customers are responsible for microSD card data protection.  
PC functions that format and delete the data may not be sufficient to fully erase the microSD card data. Yaskawa recommends that customers physically destroy the microSD card in a shredder or use data wipe software to fully erase the card.

---

### ◆ WEEE Directive



The wheeled bin symbol on this product, its manual, or its packaging identifies that you must recycle it at the end of its product life.

You must discard the product at an applicable collection point for electrical and electronic equipment (EEE). Do not discard the product with usual waste.

## 10 Specification

**Table 10.1 Option Hardware Specifications (Common)**

Item	Description
Model	<ul style="list-style-type: none"> <li>Standard specifications: JVOP-KPLEA04Axx</li> <li>Moisture resistance and dust resistance specifications: JVOP-KPLEA04Mxx</li> </ul>
Port	RJ-45
Power Supply	Supply from drive (DC +5 V $\pm$ 5%)
Operating Ambient Temperature	-10 °C to +50 °C (14 °F to 122 °F)
Operating Ambient Humidity	95% RH or less (no condensation)
Storage Ambient Temperature	-20 °C to +70 °C (-4 °F to +158 °F) (short-term storage temperature during transport)
Area of Use	Indoor (the area without corrosive gas, or dust)
Altitude	1000 m (3281 ft.) maximum
Vibration	10 to under 20 Hz: 1 G (9.8 m/s <sup>2</sup> ) 20 to under 55 Hz: 0.6 G (5.9 m/s <sup>2</sup> )
Approximately Number of Parameter Reads	100,000 or less

**Table 10.2 Moisture Resistance and Dust Resistance Specifications**

Item	Description
Model	JVOP-KPLEA04Mxx
Specification	Board surface: Apply insulating varnish (HumiSeal) to entire surface of the board excluding connectors.

## 11 Warranty

### ◆ Warranty Period and Scope

#### ■ Warranty Period

The warranty period is 12 months from the date the product is first used by the buyer, or 18 months from the date of shipment, whichever occurs first.

#### ■ Post-Warranty Repair Period

The post-warranty repair period applies to products that are not in the standard warranty period. During the post-warranty repair period, Yaskawa will repair or replace damaged parts for a fee.

There is a limit to the period during which Yaskawa will repair or replace damaged parts. Contact Yaskawa or your nearest sales representative for more information.

#### ■ Warranty Scope

- Failure diagnosis

In principle, Yaskawa requests that the primary fault diagnosis be conducted by your company. However, Yaskawa or our service network can conduct a fault diagnosis on behalf of your company for a fee, if requested. In this case, if the cause of the failure is determined to be the result of Yaskawa workmanship or materials based on discussions with the customer, this fault diagnosis will be free of charge.

- Repairs

If a Yaskawa product is found to be defective during the warranty period, Yaskawa will repair the defective product, provide a replacement, or visit the site free of charge. However, the customer will be responsible for the cost of any necessary repairs in the following cases.

- Problems due to improper storage or handling, carelessness, design content, or other reasons where you or your customers are determined to be responsible.



- 
- Problems due to additions or modifications made to a Yaskawa product without Yaskawa's consent.
  - Problems due to the use of a Yaskawa product under conditions that do not meet the range of recommended specifications for the product.
  - Problems caused by events out of Yaskawa's control, such as natural disasters or fires.
  - Problems after the free warranty period elapses.
  - Defective products due to packaging or fumigation.
  - Other problems not attributable to Yaskawa.

The above service is only available in Japan. After-sales service is available for overseas customers for a reasonable fee if using an overseas service contract.

## ■ Exceptions

Any opportunity loss to your company or damage to non-Yaskawa products, such as to you or your customers due to the failure of our products, or compensation for other business whether within or outside of the warranty period are not covered by warranty.

---

## ◆ About Application of This Product

This product is not designed or manufactured for use in life-support machines or systems.

Contact a Yaskawa representative or your Yaskawa sales representative if you are considering the application of this product for special purposes, such as machines or systems used for passenger cars, medicine, airplanes and aerospace, nuclear power, electric power, or undersea relaying.

### **▲ WARNING**

*Injury to Personnel. When you use this product in applications where its failure could cause the loss of human life, a serious accident, or physical injury, you must install applicable safety devices. If you do not correctly install safety devices, it can cause serious injury or death.*

## Revision History

Date of Publication	Revision Number	Section	Revised Content
March 2019	3	All	Revision: Reviewed and corrected entire documentation.
		Chapter 1	Addition: Compatible Models GA500
		Chapter 2	
		Chapter 5	
		Chapter 9	Addition: Disposal Instructions
March 2019	2	All	Revision: Reviewed and corrected entire documentation.
		Chapter 1	Addition: Compatible Models GA800
		Chapter 2	
June 2017	1	All	Revision: Reviewed and corrected entire documentation.
		Chapter 2	Addition: Compatible Models <ul style="list-style-type: none"> <li>• CR700</li> <li>• CH700</li> </ul>
October 2016	-	-	First Edition



# YASKAWA AC Drive Option LED Keypad Installation Manual

---

## **DRIVE CENTER (INVERTER PLANT)**

2-13-1, Nishimiyaichii, Yukuhashi, Fukuoka,  
824-8511, Japan  
Phone: +81-930-25-2548 Fax: +81-930-25-3431  
<http://www.yaskawa.co.jp>

## **YASKAWA ELECTRIC CORPORATION**

New Pier Takeshiba South Tower, 1-16-1, Kaigan,  
Minatoku, Tokyo, 105-6891, Japan  
Phone: +81-3-5402-4502 Fax: +81-3-5402-4580  
<http://www.yaskawa.co.jp>

## **YASKAWA AMERICA, INC.**

2121, Norman Drive South, Waukegan, IL 60085, U.S.A.  
Phone: +1-800-YASKAWA (927-5292) or +1-847-887-7000  
Fax: +1-847-887-7310  
<http://www.yaskawa.com>

## **YASKAWA ELÉTRICO DO BRASIL LTDA.**

777, Avenida Piraporinha, Diadema, São Paulo,  
09950-000, Brasil  
Phone: +55-11-3585-1100 Fax: +55-11-3585-1187  
<http://www.yaskawa.com.br>

## **YASKAWA EUROPE GmbH**

Hauptstraße 185, 65760 Eschborn, Germany  
Phone: +49-6196-569-300 Fax: +49-6196-569-398  
E-mail: [info@yaskawa.eu.com](mailto:info@yaskawa.eu.com)  
<http://www.yaskawa.eu.com>

## **YASKAWA ELECTRIC KOREA CORPORATION**

35F, Three IFC, 10 Gukjegeumyung-ro,  
Yeongdeungpo-gu, Seoul, 07326, Korea  
Phone: +82-2-784-7844 Fax: +82-2-784-8495  
<http://www.yaskawa.co.kr>

## **YASKAWA ASIA PACIFIC PTE. LTD.**

30A, Kallang Place, #06-01, 339213, Singapore  
Phone: +65-6282-3003 Fax: +65-6289-3003  
<http://www.yaskawa.com.sg>

## **YASKAWA ELECTRIC (THAILAND) CO., LTD.**

59, 1st-5th Floor, Flourish Building, Soi Ratchadapisek 18,  
Ratchadapisek Road, Huaykwang, Bangkok, 10310,  
Thailand  
Phone: +66-2-017-0099 Fax: +66-2-017-0799  
<http://www.yaskawa.co.th>

## **YASKAWA ELECTRIC (CHINA) CO., LTD.**

22F, Link Square 1, No.222, Hubin Road, Shanghai,  
200021, China  
Phone: +86-21-5385-2200 Fax: +86-21-5385-3299  
<http://www.yaskawa.com.cn>

## **YASKAWA ELECTRIC (CHINA) CO., LTD. BEIJING OFFICE**

Room 1011, Tower W3 Oriental Plaza, No. 1,  
East Chang An Ave.,  
Dong Cheng District, Beijing, 100738, China  
Phone: +86-10-8518-4086 Fax: +86-10-8518-4082

## **YASKAWA ELECTRIC TAIWAN CORPORATION**

12F, No. 207, Sec. 3, Beishin Rd., Shindian Dist.,  
New Taipei City 23143, Taiwan  
Phone: +886-2-8913-1333  
Fax: +886-2-8913-1513 or +886-2-8913-1519  
<http://www.yaskawa.com.tw>

## **YASKAWA INDIA PRIVATE LIMITED**

#17/A, Electronics City, Hosur Road, Bangalore,  
560 100 (Karnataka), India  
Phone: +91-80-4244-1900 Fax: +91-80-4244-1901  
<http://www.yaskawaindia.in>

---

# YASKAWA

YASKAWA ELECTRIC CORPORATION

In the event that the end user of this product is to be the military and said product is to be employed in any weapons systems or the manufacture thereof, the export will fall under the relevant regulations as stipulated in the Foreign Exchange and Foreign Trade Regulations. Therefore, be sure to follow all procedures and submit all relevant documentation according to any and all rules, regulations and laws that may apply.

Specifications are subject to change without notice for ongoing product modifications and improvements.

© 2016 YASKAWA Electric Corporation



\*T0EJPC73060074\*

MANUAL NO. TOEP C730600 74D <3>-0  
Published in Japan March 2019  
18-11-20