

TECHNICAL DATA

Three Phase Electric Motors - Cast Iron Frame
UM3C 160M-2 IE3
11 kW / 15 Cv
2950 RPM

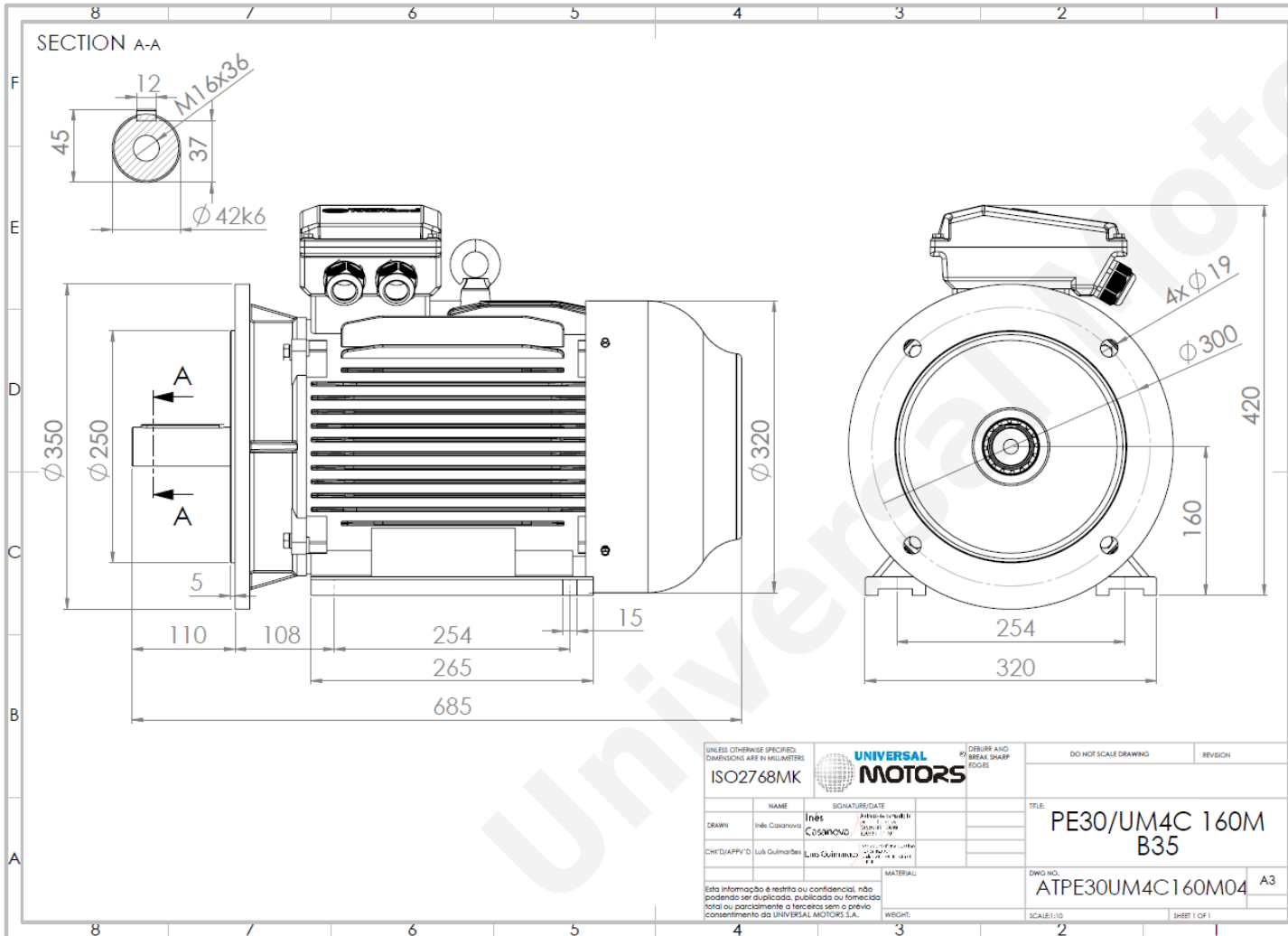

Motor type:	UM3C 160M-2 IE3
Output:	11 kW / 15 Cv
Speed (min ⁻¹):	2950 RPM
Voltage:	400 V
Frequency:	50 Hz
Current:	19.6 A
Power factor (Cos ϕ):	0.89
Poles:	2
Insulation class:	F
Temperature rise Class:	B
Efficiency 50%:	89.9 %
Efficiency 75%:	91.5 %
Efficiency 100%:	91.3 %
Torque:	36 N.m
Tstarting/Tnominal:	2.0
Istarting/Inominal:	8.1
Tmaximum/Tnominal:	2.3
Noise:	81 Db(A)
Weight:	126 Kg
Bearing DE:	6309 C3
Bearing NDE:	6309 C3

Regime - S1

Altitude - 1000m

Environment Temperature - 40°C

CONTACTS:

Universal Motors UK, Ltd
Unit E2, Meltham Mills Industrial Estate, Meltham Mills Road, Meltham, Holmfirth
West Yorkshire HD9 4AR, U.K.

Tel: +44(0) 1484 660 222

Fax: +44(0) 1484 660 333

Mail: enquiries@universalmotors-group.co.uk

* References applied only in the UK