

TECHNICAL DATA

Three Phase Electric Motors - Cast Iron Frame
 UM3C 160M-4 IE3
 11 kW / 15 Cv
 1470 RPM

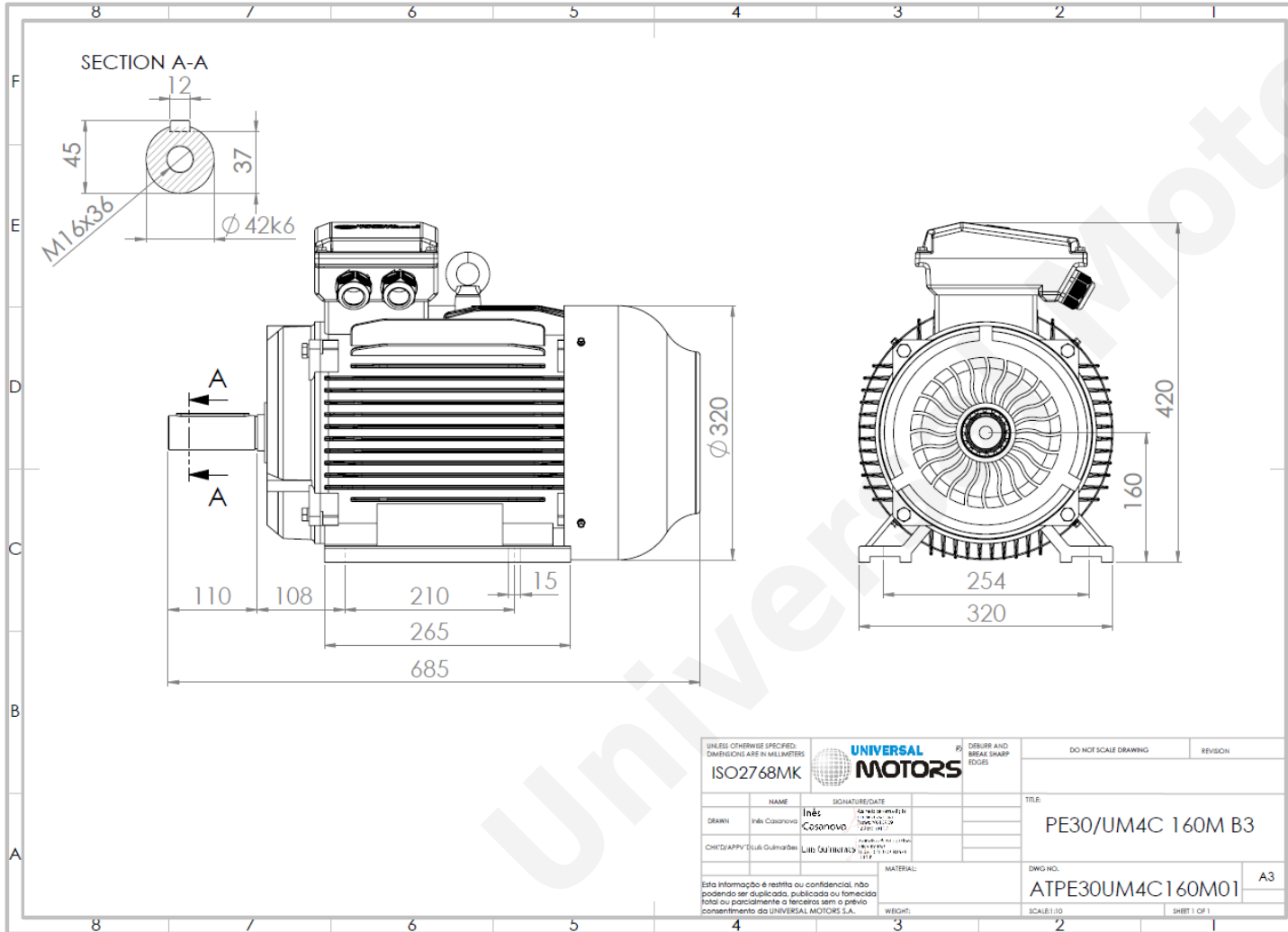

Motor type:	UM3C 160M-4 IE3
Output:	11 kW / 15 Cv
Speed (min ⁻¹):	1470 RPM
Voltage:	400 V
Frequency:	50 Hz
Current:	20.4 A
Power factor (Cos Ø):	0.85
Poles:	4
Insulation class:	F
Temperature rise Class:	B
Efficiency 50%:	90.8 %
Efficiency 75%:	91.7 %
Efficiency 100%:	91.4 %
Torque:	72 N.m
Tstarting/Tnominal:	2.2
Istarting/Inominal:	7.7
Tmaximum/Tnominal:	2.3
Noise:	73 Db(A)
Weight:	136 Kg
Bearing DE:	6309 C3
Bearing NDE:	6309 C3

Regime - S1

Altitude - 1000m

Environment Temperature - 40°C

CONTACTS:

Universal Motors UK, Ltd
 Unit E2, Meltham Mills Industrial Estate, Meltham Mills Road, Meltham, Holmfirth
 West Yorkshire HD9 4AR, U.K

Tel: +44(0) 1484 660 222

Fax: +44(0) 1484 660 333

Mail: enquiries@universalmotors-group.co.uk

* References applied only in the UK