

TECHNICAL DATA

Three Phase Electric Motors - Cast Iron Frame
 UM3C 160L-4 IE3
 15 kW / 20 Cv
 1470 RPM

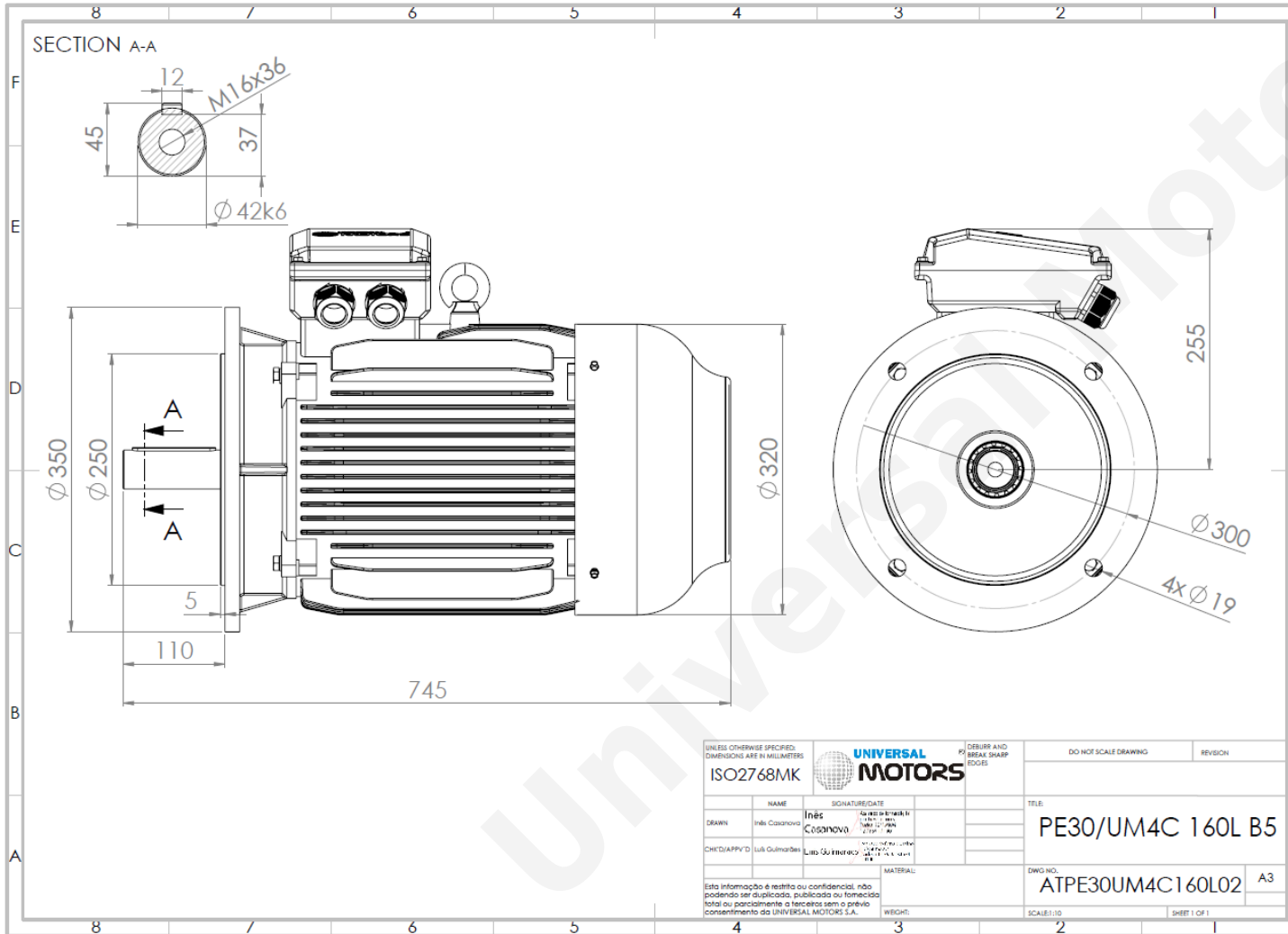

Motor type:	UM3C 160L-4 IE3
Output:	15 kW / 20 Cv
Speed (min ⁻¹):	1470 RPM
Voltage:	400 V
Frequency:	50 Hz
Current:	27.3 A
Power factor (Cos Ø):	0.86
Poles:	4
Insulation class:	F
Temperature rise Class:	B
Efficiency 50%:	91.5 %
Efficiency 75%:	92.5 %
Efficiency 100%:	92.2 %
Torque:	97 N.m
Tstarting/Tnominal:	2.2
Istarting/Inominal:	7.8
Tmaximum/Tnominal:	2.3
Noise:	73 Db(A)
Weight:	160 Kg
Bearing DE:	6309 C3
Bearing NDE:	6309 C3

Regime - S1

Altitude - 1000m

Environment Temperature - 40°C

CONTACTS:

Universal Motors UK, Ltd
 Unit E2, Meltham Mills Industrial Estate, Meltham Mills Road, Meltham, Holmfirth
 West Yorkshire HD9 4AR, U.K

Tel: +44(0) 1484 660 222

Fax: +44(0) 1484 660 333

Mail: enquiries@universalmotors-group.co.uk

* References applied only in the UK