

TECHNICAL DATA

Three Phase Electric Motors - Cast Iron Frame
UM3C 180M-2 IE3
22 kW / 30 Cv
2960 RPM

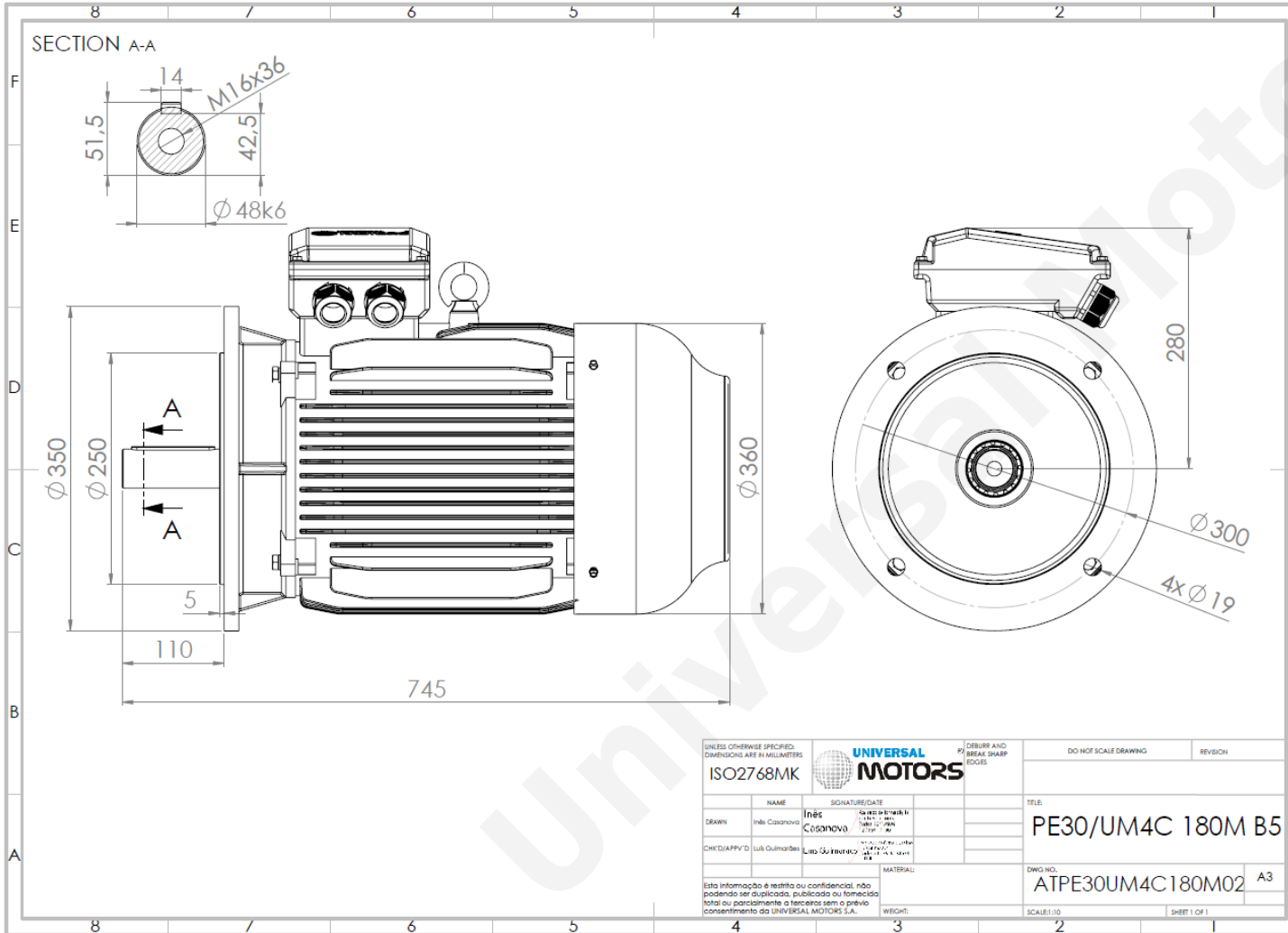

Motor type:	UM3C 180M-2 IE3
Output:	22 kW / 30 Cv
Speed (min ⁻¹):	2960 RPM
Voltage:	400 V
Frequency:	50 Hz
Current:	38.5 A
Power factor (Cos Ø):	0.89
Poles:	2
Insulation class:	F
Temperature rise Class:	B
Efficiency 50%:	91.8 %
Efficiency 75%:	92.9 %
Efficiency 100%:	92.7 %
Torque:	71 N.m
Tstarting/Tnominal:	2.0
Istarting/Inominal:	8.2
Tmaximum/Tnominal:	2.3
Noise:	83 Db(A)
Weight:	202 Kg
Bearing DE:	6311 C3
Bearing NDE:	6311 C3

Regime - S1

Altitude - 1000m

Environment Temperature - 40°C

CONTACTS:

Universal Motors UK, Ltd
Unit E2, Meltham Mills Industrial Estate, Meltham Mills Road, Meltham, Holmfirth
West Yorkshire HD9 4AR, U.K

Tel: +44(0) 1484 660 222
Fax: +44(0) 1484 660 333

Mail: enquiries@universalmotors-group.co.uk

* References applied only in the UK