

TECHNICAL DATA

Three Phase Electric Motors - Cast Iron Frame
UM3C 200L-2 IE3
30 kW / 40 Cv
2970 RPM

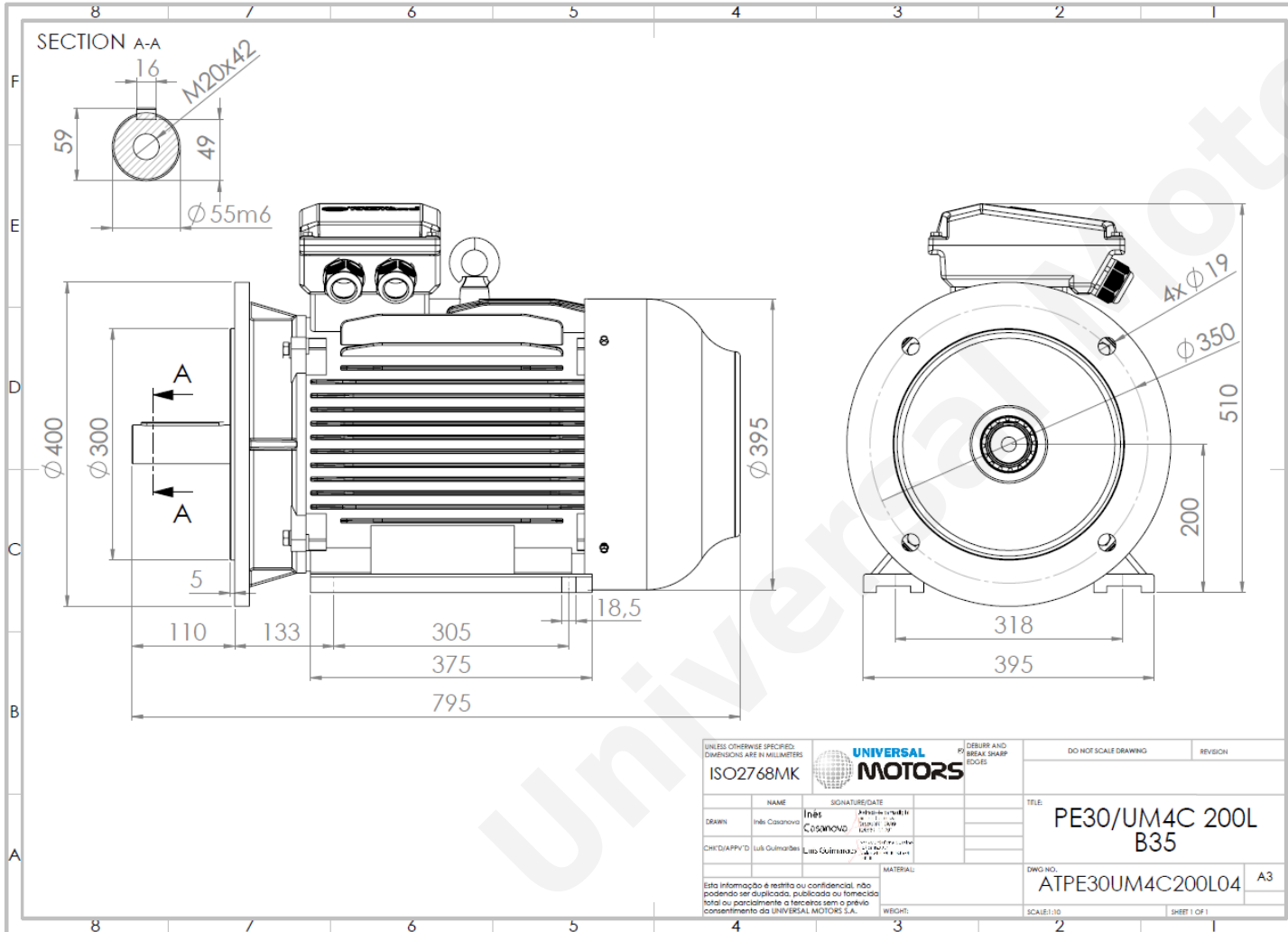

Motor type:	UM3C 200L-2 IE3
Output:	30 kW / 40 Cv
Speed (min ⁻¹):	2970 RPM
Voltage:	400 V
Frequency:	50 Hz
Current:	52.1 A
Power factor (Cos Ø):	0.89
Poles:	2
Insulation class:	F
Temperature rise Class:	B
Efficiency 50%:	92.2 %
Efficiency 75%:	93.6 %
Efficiency 100%:	93.4 %
Torque:	97 N.m
Tstarting/Tnominal:	2.0
Istarting/Inominal:	7.6
Tmaximum/Tnominal:	2.3
Noise:	84 Db(A)
Weight:	259 Kg
Bearing DE:	6312 C3
Bearing NDE:	6312 C3

Regime - S1

Altitude - 1000m

Environment Temperature - 40°C

CONTACTS:

Universal Motors UK, Ltd
Unit E2, Meltham Mills Industrial Estate, Meltham Mills Road, Meltham, Holmfirth
West Yorkshire HD9 4AR, U.K

Tel: +44(0) 1484 660 222

Fax: +44(0) 1484 660 333

Mail: enquiries@universalmotors-group.co.uk

* References applied only in the UK