

TECHNICAL DATA

Three Phase Electric Motors - Cast Iron Frame
UM3C 225M-2 IE3
45 kW / 60 Cv
2970 RPM

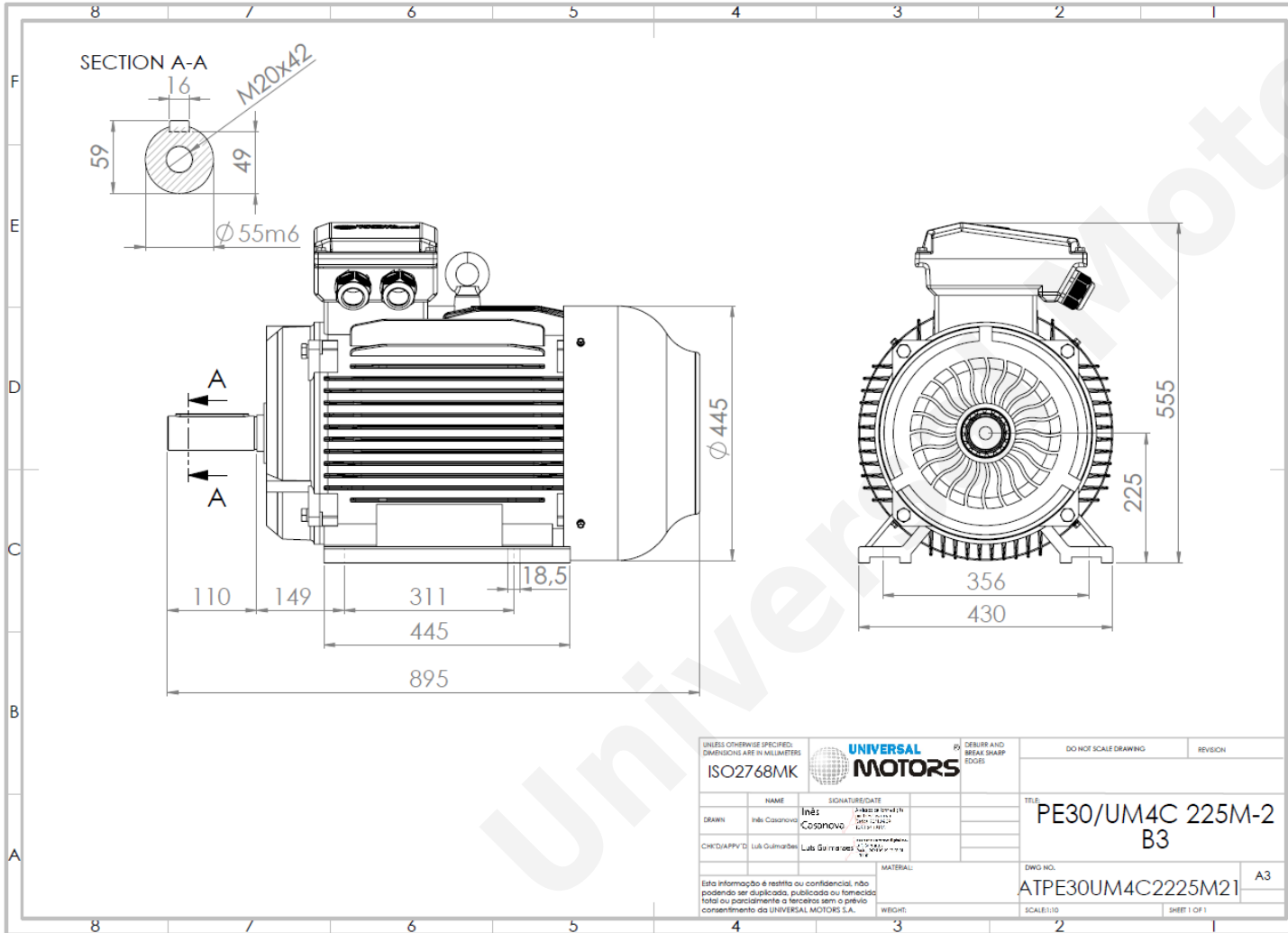

| | |
|-----------------------------|------------------------|
| Motor type: | UM3C 225M-2 IE3 |
| Output: | 45 kW / 60 Cv |
| Speed (min ⁻¹): | 2970 RPM |
| Voltage: | 400 V |
| Frequency: | 50 Hz |
| Current: | 76.8 A |
| Power factor (Cos Ø): | 0.90 |
| Poles: | 2 |
| Insulation class: | F |
| Temperature rise Class: | B |
| Efficiency 50%: | 92.7 % |
| Efficiency 75%: | 94.0 % |
| Efficiency 100%: | 94.1 % |
| Torque: | 145 N.m |
| Tstarting/Tnominal: | 2.0 |
| Istarting/Inominal: | 7.7 |
| Tmaximum/Tnominal: | 2.3 |
| Noise: | 86 Db(A) |
| Weight: | 359 Kg |
| Bearing DE: | 6313 C3 |
| Bearing NDE: | 6313 C3 |

Regime - S1

Altitude - 1000m

Environment Temperature - 40°C

CONTACTS:

Universal Motors UK, Ltd
Unit E2, Meltham Mills Industrial Estate, Meltham Mills Road, Meltham, Holmfirth
West Yorkshire HD9 4AR, U.K.

Tel: +44(0) 1484 660 222

Fax: +44(0) 1484 660 333

Mail: enquiries@universalmotors-group.co.uk

* References applied only in the UK