

# TECHNICAL DATA

Three Phase Electric Motors - Cast Iron Frame  
 UM3C 250M-4 IE3  
 55 kW / 75 Cv  
 1485 RPM

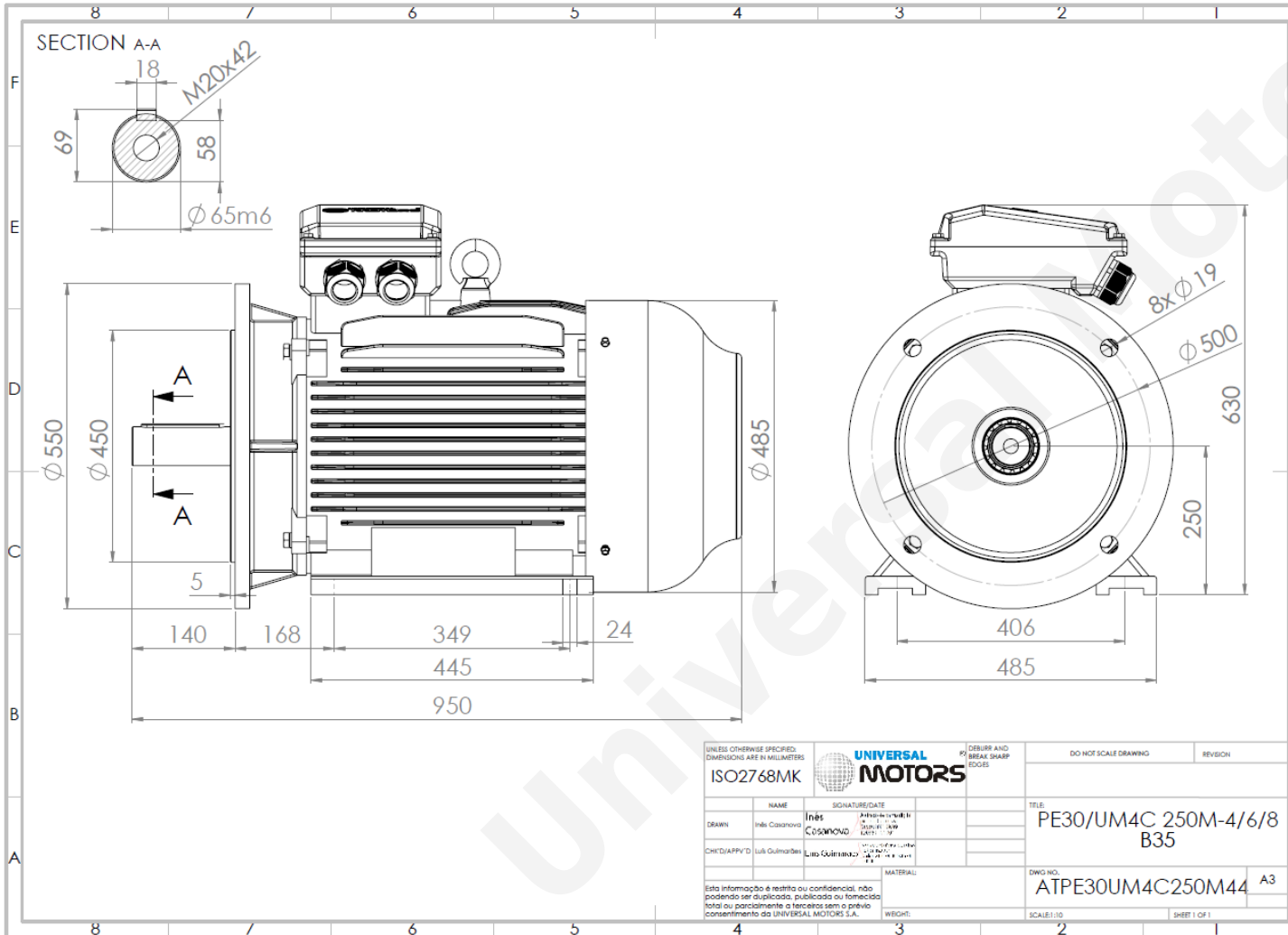

Motor type:	<b>UM3C 250M-4 IE3</b>
Output:	<b>55 kW / 75 Cv</b>
Speed (min <sup>-1</sup> ):	<b>1485 RPM</b>
Voltage:	<b>400 V</b>
Frequency:	<b>50 Hz</b>
Current:	<b>97.6 A</b>
Power factor (Cos $\phi$ ):	<b>0.86</b>
Poles:	<b>4</b>
Insulation class:	<b>F</b>
Temperature rise Class:	<b>B</b>
Efficiency 50%:	<b>93.6 %</b>
Efficiency 75%:	<b>94.8 %</b>
Efficiency 100%:	<b>94.6 %</b>
Torque:	<b>354 N.m</b>
Tstarting/Tnominal:	<b>2.0</b>
Istarting/Inominal:	<b>7.4</b>
Tmaximum/Tnominal:	<b>2.3</b>
Noise:	<b>79 Db(A)</b>
Weight:	<b>433 Kg</b>
Bearing DE:	<b>6314 C3</b>
Bearing NDE:	<b>6314 C3</b>

Regime - S1

Altitude - 1000m

Environment Temperature - 40°C

**CONTACTS:**

Universal Motors UK, Ltd  
 Unit E2, Meltham Mills Industrial Estate, Meltham Mills Road, Meltham, Holmfirth  
 West Yorkshire HD9 4AR, U.K

Tel: +44(0) 1484 660 222  
 Fax: +44(0) 1484 660 333  
 Mail: [enquiries@universalmotors-group.co.uk](mailto:enquiries@universalmotors-group.co.uk)

\* References applied only in the UK