

TECHNICAL DATA

Three Phase Electric Motors - Cast Iron Frame
UM3C 280S-6 IE3
45 kW / 60 Cv
990 RPM

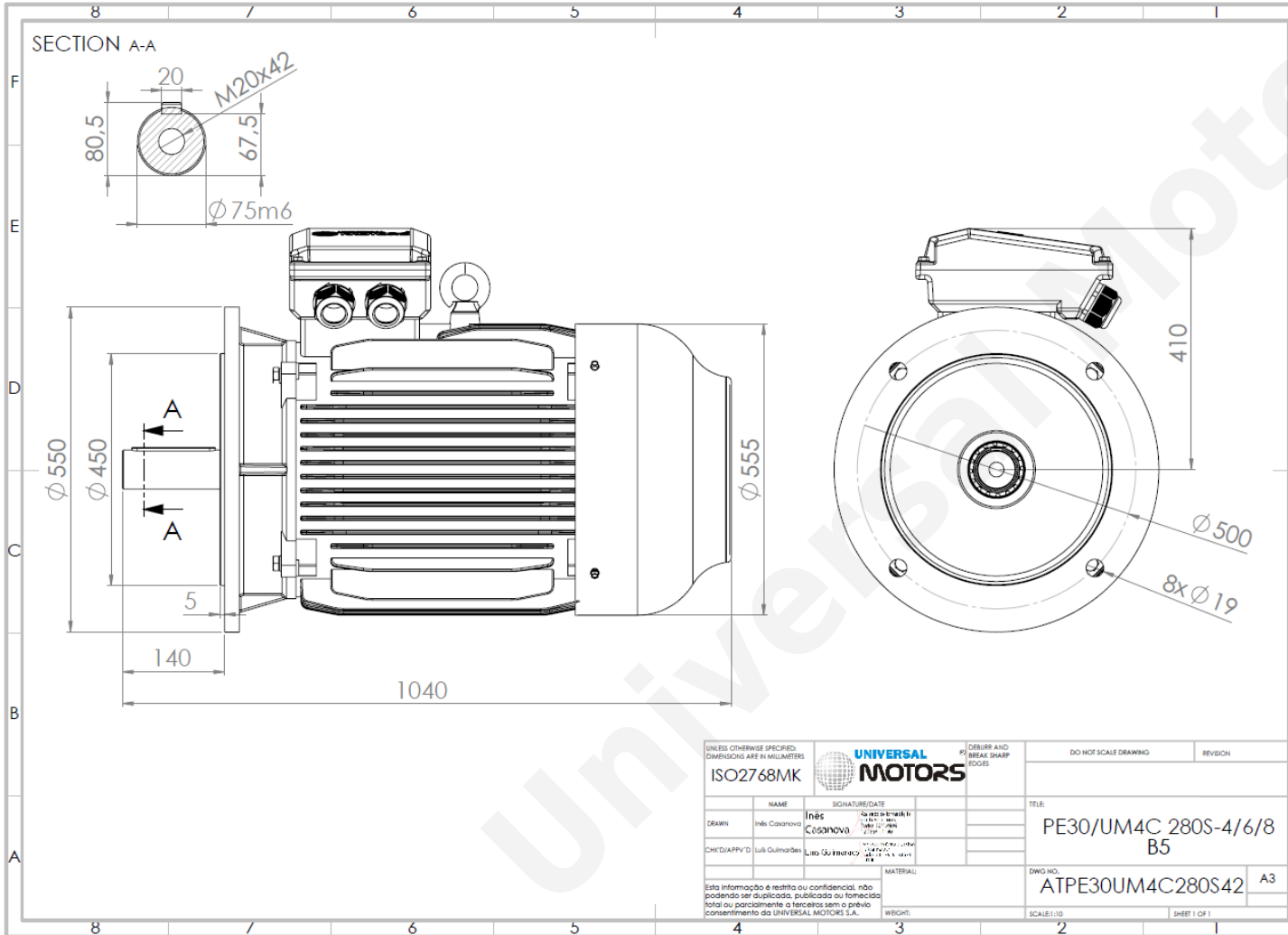

Motor type:	UM3C 280S-6 IE3
Output:	45 kW / 60 Cv
Speed (min ⁻¹):	990 RPM
Voltage:	400 V
Frequency:	50 Hz
Current:	81.6 A
Power factor (Cos ϕ):	0.85
Poles:	6
Insulation class:	F
Temperature rise Class:	B
Efficiency 50%:	92.9 %
Efficiency 75%:	93.7 %
Efficiency 100%:	93.8 %
Torque:	434 N.m
Tstarting/Tnominal:	2.0
Istarting/Inominal:	7.3
Tmaximum/Tnominal:	2.0
Noise:	78 Db(A)
Weight:	522 Kg
Bearing DE:	6317 C3
Bearing NDE:	6317 C3

Regime - S1

Altitude - 1000m

Environment Temperature - 40°C

CONTACTS:

Universal Motors UK, Ltd
Unit E2, Meltham Mills Industrial Estate, Meltham Mills Road, Meltham, Holmfirth
West Yorkshire HD9 4AR, U.K.

Tel: +44(0) 1484 660 222
Fax: +44(0) 1484 660 333
Mail: enquiries@universalmotors-group.co.uk

* References applied only in the UK