

# TECHNICAL DATA

Three Phase Electric Motors - Cast Iron Frame  
 UM3C 180L-6 IE3  
 15 kW / 20 Cv  
 980 RPM

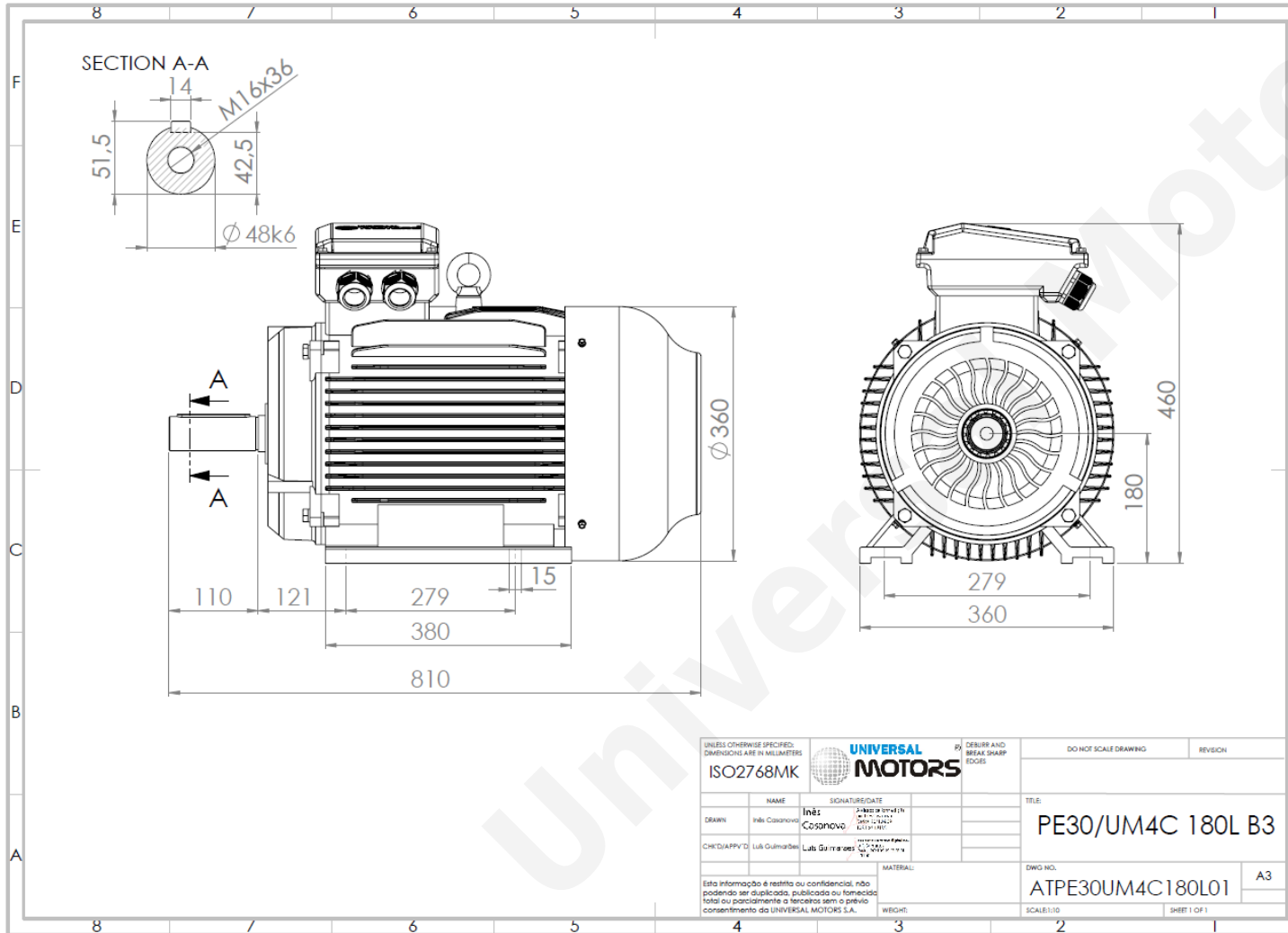

Motor type:	<b>UM3C 180L-6 IE3</b>
Output:	<b>15 kW / 20 Cv</b>
Speed (min <sup>-1</sup> ):	<b>980 RPM</b>
Voltage:	<b>400 V</b>
Frequency:	<b>50 Hz</b>
Current:	<b>29.3 A</b>
Power factor (Cos Ø):	<b>0.81</b>
Poles:	<b>6</b>
Insulation class:	<b>F</b>
Temperature rise Class:	<b>B</b>
Efficiency 50%:	<b>90.3 %</b>
Efficiency 75%:	<b>91.5 %</b>
Efficiency 100%:	<b>91.3 %</b>
Torque:	<b>146 N.m</b>
Tstarting/Tnominal:	<b>2.0</b>
Istarting/Inominal:	<b>7.3</b>
Tmaximum/Tnominal:	<b>2.1</b>
Noise:	<b>73 Db(A)</b>
Weight:	<b>211 Kg</b>
Bearing DE:	<b>6311 C3</b>
Bearing NDE:	<b>6311 C3</b>

Regime - S1

Altitude - 1000m

Environment Temperature - 40°C

**CONTACTS:**

Universal Motors UK, Ltd  
 Unit E2, Meltham Mills Industrial Estate, Meltham Mills Road, Meltham, Holmfirth  
 West Yorkshire HD9 4AR, U.K

Tel: +44(0) 1484 660 222  
 Fax: +44(0) 1484 660 333

Mail: [enquiries@universalmotors-group.co.uk](mailto:enquiries@universalmotors-group.co.uk)

\* References applied only in the UK