

# TECHNICAL DATA

Three Phase Electric Motors - Aluminum Frame  
 UM3A 90L-2 IE3  
 2.2 kW / 3 Cv  
 2845 RPM

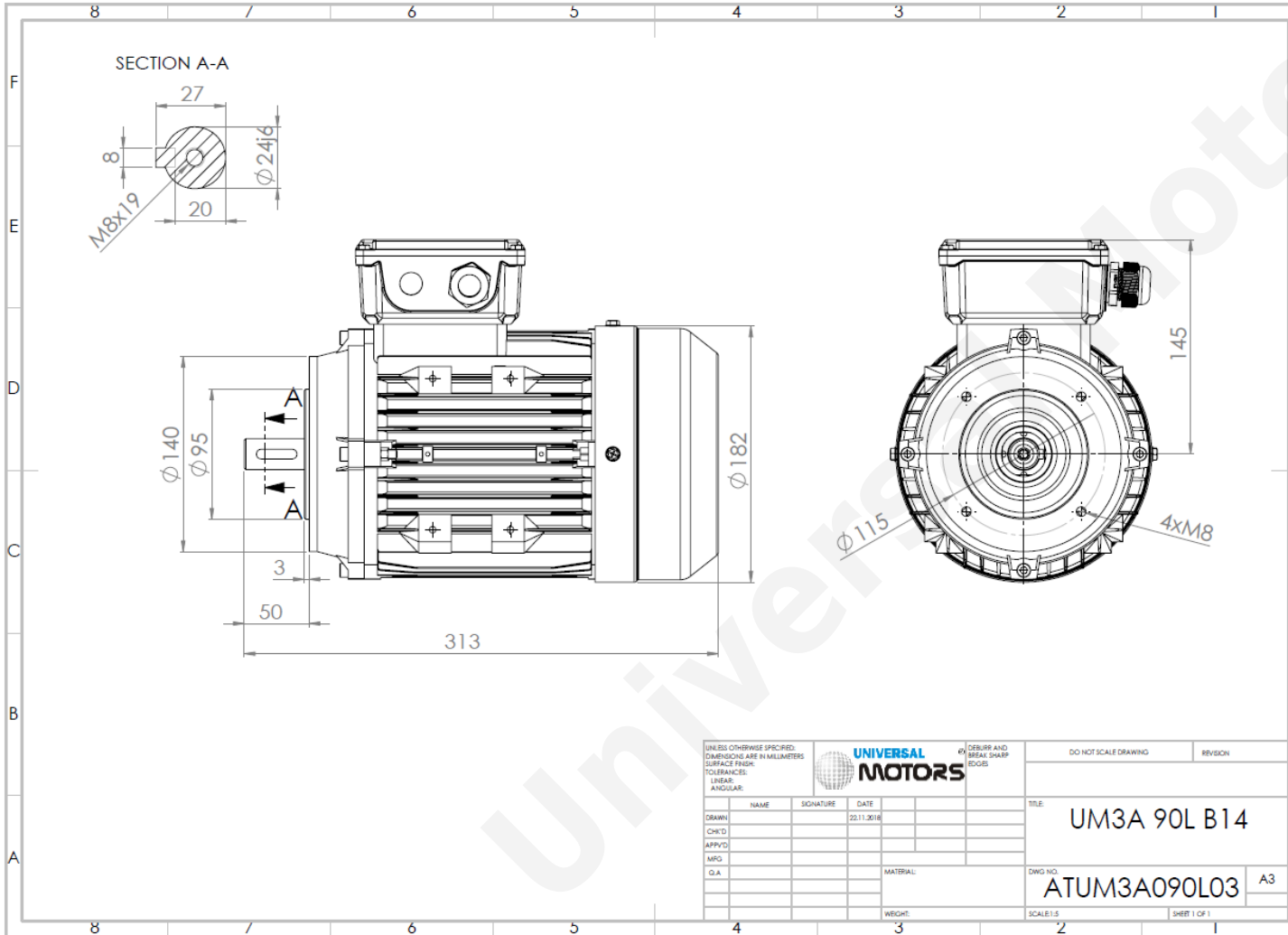

Motor type:	<b>UM3A 90L-2 IE3</b>
Output:	<b>2.2 kW / 3 Cv</b>
Speed (min <sup>-1</sup> ):	<b>2845 RPM</b>
Voltage:	<b>400 V</b>
Frequency:	<b>50 Hz</b>
Current:	<b>4.4 A</b>
Power factor (Cos $\phi$ ):	<b>0.85</b>
Poles:	<b>2</b>
Insulation class:	<b>F</b>
Temperature rise Class:	<b>B</b>
Efficiency 50%:	<b>83.8 %</b>
Efficiency 75%:	<b>84.6 %</b>
Efficiency 100%:	<b>85.9 %</b>
Torque:	<b>7.38 N.m</b>
Tstarting/Tnominal:	<b>2.3</b>
Istarting/Inominal:	<b>7.8</b>
Tmaximum/Tnominal:	<b>2.3</b>
Noise:	<b>78 Db(A)</b>
Weight:	<b>16 Kg</b>
Bearing DE:	<b>6205 2Z C3</b>
Bearing NDE:	<b>6204 2Z C3</b>

Regime - S1

Altitude - 1000m

Environment Temperature - 40°C

**CONTACTS:**

Universal Motors UK, Ltd  
 Unit E2, Meltham Mills Industrial Estate, Meltham Mills Road, Meltham, Holmfirth  
 West Yorkshire HD9 4AR, U.K

Tel: +44(0) 1484 660 222

Fax: +44(0) 1484 660 333

Mail: [enquiries@universalmotors-group.co.uk](mailto:enquiries@universalmotors-group.co.uk)

\* References applied only in the UK