

TECHNICAL DATA

Three Phase Electric Motors - Aluminum Frame
UMHA 90L-2 IE2
2.2 kW / 3 Cv
2845 RPM

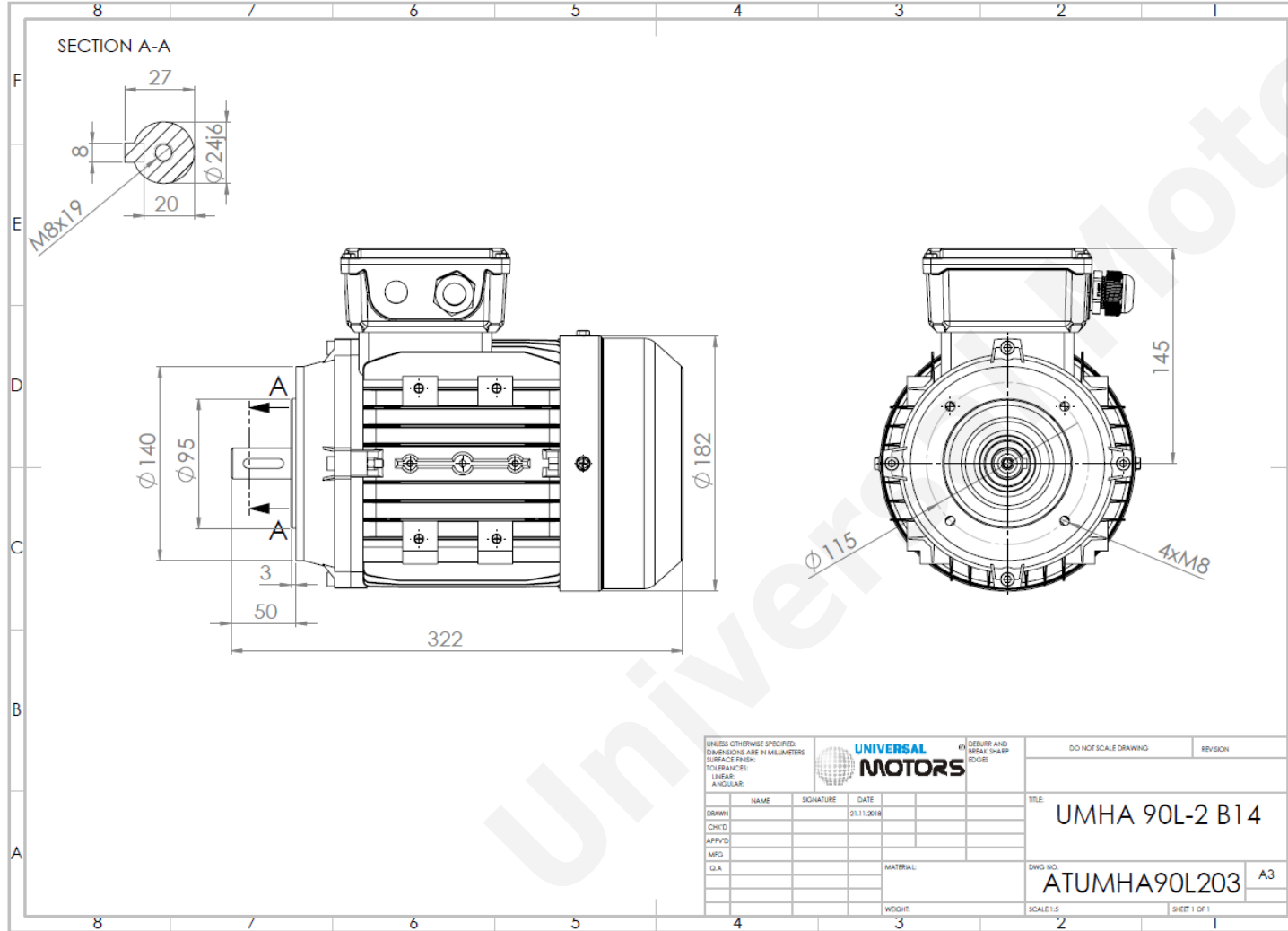

Motor type:	UMHA 90L-2 IE2
Output:	2.2 kW / 3 Cv
Speed (min ⁻¹):	2845 RPM
Voltage:	400 V
Frequency:	50 Hz
Current:	4.5 A
Power factor (Cos Ø):	0.85
Poles:	2
Insulation class:	F
Temperature rise Class:	B
Efficiency 50%:	83.2 %
Efficiency 75%:	83.7 %
Efficiency 100%:	83.2 %
Torque:	7.38 N.m
Tstarting/Tnominal:	2.3
Istarting/Inominal:	7.8
Tmaximum/Tnominal:	2.3
Noise:	78 Db(A)
Weight:	16.0 Kg
Bearing DE:	6205 2Z C3
Bearing NDE:	6204 2Z C3

Regime - S1

Altitude - 1000m

Environment Temperature - 40°C

CONTACTS:

ACDC Drives Ltd
Units 96 C & D, Blackpole Trading Estate, Blackpole Road,
Worcester, WR3 8TJ

Tel: +44(0) 1905 887 667
Mail: sales@acdcdrives.co.uk

* References applied only in the UK